

# Premium Fasteners

C-F-UK-2024 | [strongtie.co.uk](http://strongtie.co.uk)

**SIMPSON**

**Strong-Tie**

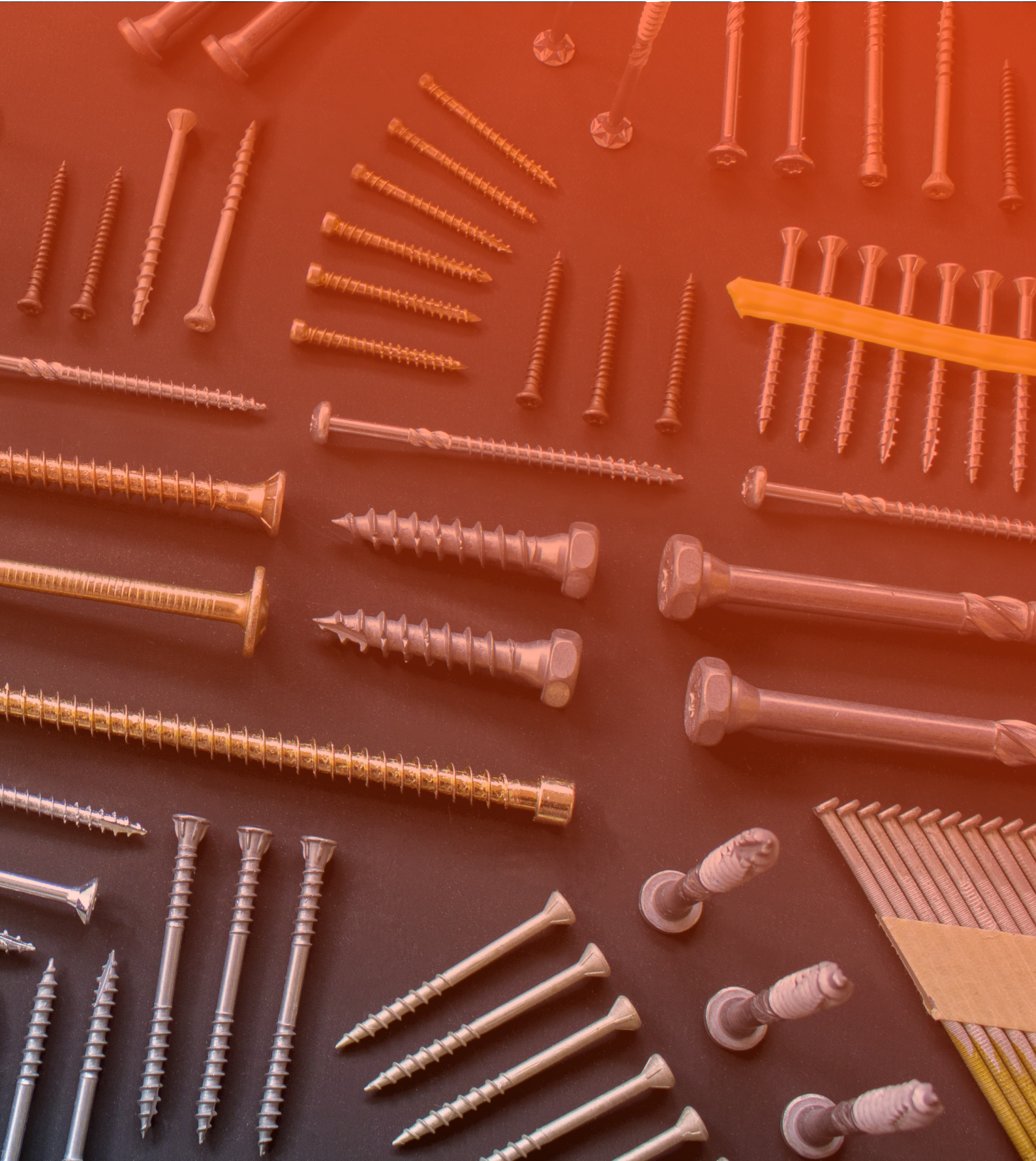

# Premium Fasteners

## The No-Equal Standard

Our PREMIUM FASTENER range includes nails and screws to cover almost every application. With a variety of geometries, threads, point types and coatings, as well as collated solutions, including the Quik Drive<sup>®</sup> auto-feed screw system, our range of fasteners have the details that help you deliver on the job performance.





At Simpson Strong-Tie®, we've built a legacy of high-level engineering support, highly specialized training and widespread product availability. Our passion for innovation and dedication to customer service ensure that you're equipped with the solutions and technical knowledge you need to succeed. No matter what you're building, we help you build it better.

# Table of Contents

## General Information

Company Information . . . . .	10
Online Tools & Support for Engineers . . . . .	12
Fastener Features . . . . .	13
Self-Drilling Screws . . . . .	15
Materials and Coatings . . . . .	16
Understanding the Corrosion Issue . . . . .	18
Galvanic Corrosion . . . . .	18

## Fastener Application Guide

Solid Wood Applications . . . . .	22
CLT and Mass Timber Applications . . . . .	23
Fasteners for Simpson Strong-Tie® Connectors . . . . .	24
Drywall . . . . .	25
Mezzanine Floor . . . . .	26
Truckbeds . . . . .	26
Subfloor and Wood Sheathing Applications . . . . .	27
Decks, Docks and Boardwalks . . . . .	28
Cladding . . . . .	30
Fibre Cement & Wood Fibre Board Applications . . . . .	31
Metal to Metal . . . . .	32
Wood to Metal . . . . .	33

## Screws

### Connector Screws

CSA CONNECTOR Screw . . . . .	36
CSFT Full Thread CONNECTOR Screw . . . . .	37
SSH Hex-Head CONNECTOR Screw . . . . .	38

### Structural Wood Screws

SWW Structural Washer Head WOOD Screw . . . . .	41
SWC Structural Countersunk WOOD Screw . . . . .	43
SWD Structural Double Threaded WOOD Screw . . . . .	45
ESCRFTC Fully Threaded Countersunk WOOD Screw . . . . .	46
ESCRFTZ/ESCRFT Fully Threaded WOOD Screw . . . . .	47
SDW Structural WOOD Screw . . . . .	48

TTUFS/TTSFS Countersunk WOOD Screw . . . . .	49
--	----

### Decking Screws

TTFA4 DECKING Screw, Stainless A4 . . . . .	52
DSIX4 DECKING Screw, Impreg® X4 . . . . .	53
DSPROA4 HARDWOOD DECKING Screw, Stainless . . . . .	54

### Facade Screws

CLSA4 Wood FACADE Screw . . . . .	54
-----------------------------------	----

### Assembly Screws

SSP/FSM Steel to STEEL Screws . . . . .	55
HS/HSB Steel to STEEL Screws . . . . .	56

### Board Screws

FBCS FIBRE CEMENT Screw . . . . .	57
FBCB FIBRE CEMENT Screw, Drill point . . . . .	58

### Parts and Accessories

	59
--	----

## Nails

### Connector Nails

CNA CONNECTOR Nail . . . . .	62
N3.75 SQUARE TWIST Nail . . . . .	63

### Wood Nails

ARA4 RING-SHANK WOOD Nail, Stainless A4 . . . . .	64
---	----

### Cladding Nails

CLNA4/CLNG WOOD-CLADDING Nail . . . . .	65
---	----

## Collated Nails

### Collated Connector Nails

34° CNA CONNECTOR Nail, Paper Strip . . . . .	68
---	----

### Collated Wood Framing Nails

34° RSN WOOD-FRAMING Nail, Paper Tape . . . . .	69
34° RSND WOOD-FRAMING Nail, Paper Tape . . . . .	69

# Table of Contents

## Quik Drive® Systems

### Quik Drive® Systems

QDBPC50E Connector Screw System . . . . .	75
QDBPC19EF 19 mm Flooring Screw System . . . . .	76
QDPRO76SKE Flooring and Decking System . . . . .	77
QDHSD Mezzanine Floor/Truck Bed System . . . . .	78
QDPRO51E Drywall Screw System . . . . .	80
QDPRO64E Flooring and Decking System . . . . .	81
QD76KE Multi-purpose System . . . . .	82
QDPRORFE Roofing Tile System . . . . .	83
QDPROLDHG2 Fibre Cement Board System . . . . .	84
QDPROPHG2 Light Gauge Steel Stud and Track System . . . . .	85
QDPROHX516G2 Metal Sheeting or Cladding System . . . . .	86
QDPROPP38KE Metal-Roofing Clips/Steel Decking/Stitching . . . . .	87
<b>Quik Drive® Bits</b>	
Driver Bits . . . . .	88
<b>Quik Drive® Adapters</b>	
Adapters for Corded Screwgun Motors . . . . .	89
Adapters for Cordless Screwgun Motors . . . . .	90
Adapter Installation Instructions . . . . .	90
<b>Quik Drive® Accessories</b>	
Accessories . . . . .	91
<b>General Information</b>	
Quik Drive® System Components . . . . .	73
Quik Drive® System Features . . . . .	73
Quik Drive® System Troubleshooting Guide . . . . .	93

## Collated Screws for the Quik Drive® System

### Collated Drywall Screws

DWC DRYWALL to Wood Screw . . . . .	96
DWF DRYWALL to Steel Screw . . . . .	97
DWHL DRYWALL to Wood and Steel Screw . . . . .	98
DWFSD DRYWALL to Steel Screw . . . . .	98
RDPF DIAMOND BOARD® to Wood and Steel Screw . . . . .	99
RDWF DRYWALL to Wood and Steel Screw . . . . .	99

RTFSD HARD-DRYWALL to Steel Screw . . . . .	99
---	----

### Collated Underlayment and Board Screws

MTH UNDERLAYMENT to Wood or Steel Screw . . . . .	100
WSHL45E UNDERLAYMENT to Wood Screw . . . . .	101
FHSD MEZZANINE FLOOR Screw . . . . .	102
CBSDQ FIBRE CEMENT BOARD to Steel Screw . . . . .	103
CB3BLGHL Fibre Cement Board to Wood Screw . . . . .	103
FBCS-E/FBCB-E FIBRE CEMENT Screw . . . . .	104

### Collated Truck Bed Screw

TBG TRUCK BED Screw, Outdoor . . . . .	105
--	-----

### Collated Standing Seam Screws

PCULP Standing-Seam Roofing Screw . . . . .	105
---	-----

### Collated Connectors Screws

CSA CONNECTOR Screw . . . . .	106
-------------------------------	-----

### Collated Wood Flooring Screws

WSV Subfloor Screw . . . . .	107
WSC Wood Flooring Screw, Coarse Thread . . . . .	108

### Collated Wood Screws

CHB Wood Fibre to Wood Screw . . . . .	109
--	-----

### Collated Cladding and Decking Screws

CLSZN-E Wood FACADE Screw . . . . .	110
SSDTH Wood Cladding and Decking Screw . . . . .	110
SS3DSC Decking Screw . . . . .	111
DTHQ Trim Head Wood Screw . . . . .	111
SSDHPD Hardwood-Decking Screw . . . . .	112
SSBFHSD Bi-Metal WOOD to METAL Screw . . . . .	112

### Collated Roofing Tile Screws

SSWSCB Tile Roofing Screw, Coarse Thread . . . . .	113
--	-----

### Collated Steel Framing and Metal Screws

PHSD Steel Framing Screw, Pan Head . . . . .	114
FPHSD Steel Framing Screw, Flat Head . . . . .	114
X Self-Drilling Metal Screw . . . . .	114

## Index

Alphabetical Index . . . . .	116
------------------------------	-----

# Alphabetical Index

34° CNA CONNECTOR Nail, Paper Strip . . . . .	68
34° RSN WOOD-FRAMING Nail, Paper Tape . . . . .	69
34° RSND WOOD-FRAMING Nail, Paper Tape . . . . .	69

## A

ARA4 RING-SHANK WOOD Nail, Stainless A4 . . . . .	64
---	----

## C

CB3BLGHL Fibre Cement Board to Wood Screw . . . . .	103
CBSDQ FIBRE CEMENT BOARD to Steel Screw . . . . .	103
CHB Wood Fibre to Wood Screw . . . . .	109
CLNA4/CLNG WOOD-CLADDING Nail . . . . .	65
CLSA4 Wood FACADE Screw . . . . .	54
CLSZN-E Wood FACADE Screw . . . . .	110
CNA CONNECTOR Nail . . . . .	62
CSA CONNECTOR Screw . . . . .	36
CSA CONNECTOR Screw . . . . .	106
CSFT Full Thread CONNECTOR Screw . . . . .	37

## D

Driver Bits . . . . .	88
DSIX4 DECKING Screw, Impreg® X4 . . . . .	53
DSPROA4 HARDWOOD DECKING Screw, Stainless . . . . .	54
DTHQ Trim Head Wood Screw . . . . .	111
DWC DRYWALL to Wood Screw . . . . .	96
DWF DRYWALL to Steel Screw . . . . .	97
DWFSD DRYWALL to Steel Screw . . . . .	98
DWHL DRYWALL to Wood and Steel Screw . . . . .	98

## E

ESCRFTC Fully Threaded Countersunk WOOD Screw . . . . .	46
ESCRFTZ/ESCRFT Fully Threaded WOOD Screw . . . . .	47

## F

FHSD MEZZANINE FLOOR Screw . . . . .	102
FPHSD Steel Framing Screw, Flat Head . . . . .	114

## H

HS/HSB Steel to STEEL Screws . . . . .	56
--	----

## M

MTH UNDERLAYMENT to Wood or Steel Screw . . . . .	100
---	-----

## N

N3.75 SQUARE TWIST Nail . . . . .	63
-----------------------------------	----

## P

Parts and Accessories . . . . .	59
PCULP Standing-Seam Roofing Screw . . . . .	105
PHSD Steel Framing Screw, Pan Head . . . . .	114

## Q

QD76KE Multi-purpose System . . . . .	82
QDBPC19EF 19 mm Flooring Screw System . . . . .	76
QDBPC50E Connector Screw System . . . . .	75
QDHSD Mezzanine Floor/Truck Bed System . . . . .	78

# Alphabetical Index

QDPRO51E Drywall Screw System . . . . .	80
QDPRO64E Flooring and Decking System . . . . .	81
QDPRO76SKE Flooring and Decking System . . . . .	77
QDPROHX516G2 Metal Sheeting or Cladding System . . . . .	86
QDPROLDHG2 Fibre Cement Board System . . . . .	84
QDPROPHG2 Light Gauge Steel Stud and Track System . . . . .	85
QDPROPP38KE Metal-Roofing Clips/Steel Decking/Stitching . . . . .	87
QDPRORFE Roofing Tile System . . . . .	83
Quik Drive® System Components . . . . .	73
Quik Drive® System Features . . . . .	73
Quik Drive® System Troubleshooting Guide. . . . .	93

## R

RDPF DIAMOND BOARD® to Wood and Steel Screw . . . . .	99
RDWF DRYWALL to Wood and Steel Screw . . . . .	99
RTFSD HARD-DRYWALL to Steel Screw . . . . .	99

## S

SDW Structural WOOD Screw . . . . .	48
SS3DSC Decking Screw . . . . .	111
SSBFHSD Bi-Metal WOOD to METAL Screw . . . . .	112
SSDHPD Hardwood-Decking Screw . . . . .	112
SSDTH Wood Cladding and Decking Screw . . . . .	110
SSH Hex-Head CONNECTOR Screw . . . . .	38
SSP/FSM Steel to STEEL Screws. . . . .	55
SSWSCB Tile Roofing Screw, Coarse Thread . . . . .	113
SWC Structural Countersunk WOOD Screw . . . . .	43
SWD Structural Double Threaded WOOD Screw . . . . .	45
SWW Structural Washer Head WOOD Screw . . . . .	41

## T

TBG TRUCK BED Screw, Outdoor . . . . .	105
TTFA4 DECKING Screw, Stainless A4. . . . .	52
TTUFS/TTSFS Countersunk WOOD Screw . . . . .	49

## W

WSC Wood Flooring Screw, Coarse Thread . . . . .	108
WSHL45E UNDERLAYMENT to Wood Screw . . . . .	101
WSV Subfloor Screw. . . . .	107

## X

X Self-Drilling Metal Screw. . . . .	114
--------------------------------------	-----



**Exceptional  
strength.**

SDW Structural WOOD Screw





# General Information



Company Information	10
Online Tools & Support for Engineers	12
Fastener Features	13
Self-Drilling Screws	15
Materials and Coatings	16
Understanding the Corrosion Issue	18
Galvanic Corrosion	18

## Company Information

For more than 60 years, Simpson Strong-Tie® has focused on creating structural products that help people build safer and stronger homes and buildings. A leader in structural systems research and technology, Simpson Strong-Tie® is one of the largest suppliers of structural building products in the world. Our commitment to product development, engineering, testing and training is evident in the consistent quality and delivery of our products and services.

For more information, visit the company's website at [strongtie.co.uk](https://strongtie.co.uk)

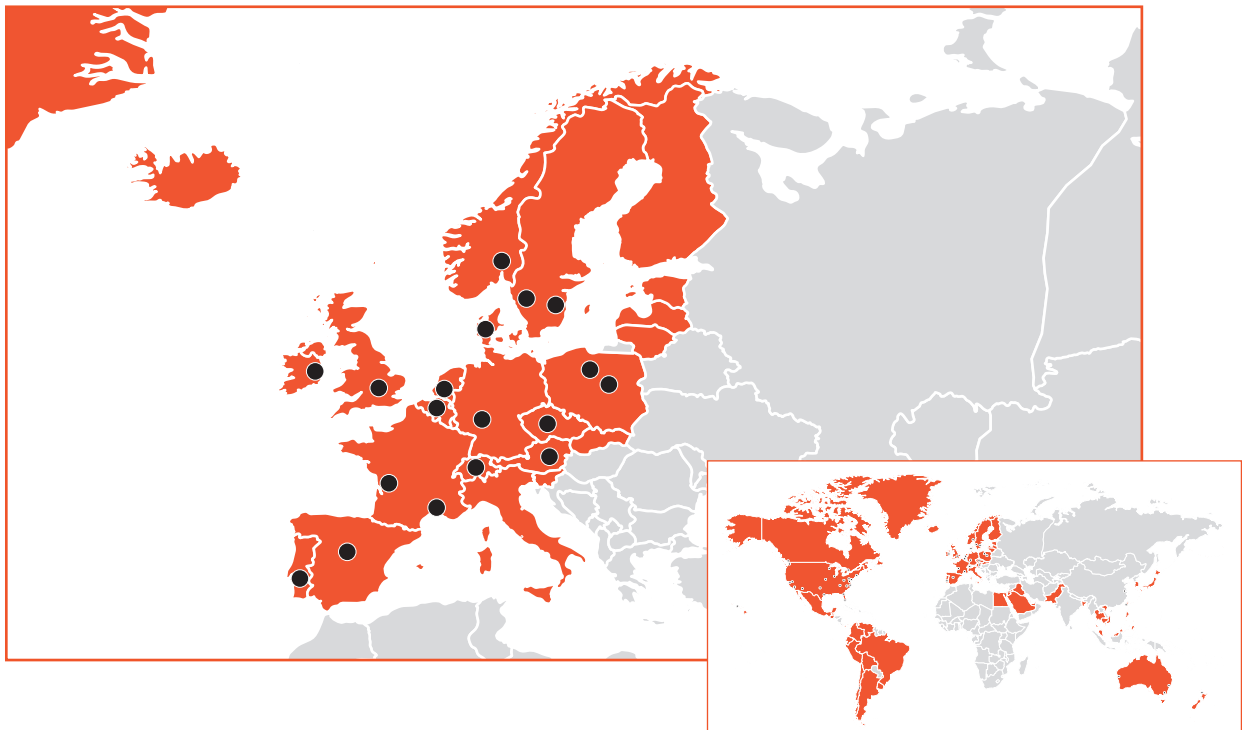

● Factories, offices, or warehouses in Australia, Austria, Belgium, Canada, Chile, China, Czech Republic, Denmark, France, Germany, Ireland, Italy, Netherlands, New Zealand, Norway, Poland, Portugal, Spain, Sweden, Switzerland, Taiwan, UK and USA

■ Distribution in Australia, Canada, Chile, Western Europe, part of Eastern Europe, Middle East, Egypt, Japan, Korea and other Asian countries, Mexico, New Zealand, UK, part of South America and USA

## European Fastener Manufacturing

Simpson Strong-Tie® has several manufacturing facilities placed strategically across the European continent, to ensure a high degree of product availability and a strong understanding of the local markets. We have fastener manufacturing in various locations across Europe and our close-knit logistical network ensures that there is always a Simpson Strong-Tie warehouse or distributor near you.

© Simpson Strong-Tie - [strongtie.co.uk](https://strongtie.co.uk)

All rights reserved. This catalogue may not be reproduced in whole or in part without the prior written approval of Simpson Strong-Tie Company Inc.

## Company Information

# The Simpson Strong-Tie® Company Inc. “No Equal” Pledge Includes:

- Quality products value-engineered for the lowest installed cost at the highest-rated performance levels
- Most thoroughly tested and evaluated products in the industry
- Strategically located manufacturing and warehouse facilities
- National code agency listings
- Largest number of patented connectors in the industry
- European locations with an international sales team
- In-house R&D, tool and die professionals
- In-house product testing and quality control engineers

## Quality Policy

We help people build safer structures economically. We do this by designing, engineering and manufacturing “No Equal” structural connectors and other related products that meet or exceed our customers’ needs and expectations.

Everyone is responsible for product quality and is committed to ensuring the effectiveness of the Quality Management System. Simpson Strong-Tie® is an ISO 9001 registered company. ISO 9001 is an internationally recognised quality management system standard, which lets our customers know that they can count on the consistent quality of Simpson Strong-Tie’s products and services.

**Mike Olosky**  
Chief Executive Officer

## Testing Laboratory Accreditation



The Andris Peterson European Test Laboratory, located in the UK in Tamworth, Staffordshire, is the first manufacturer’s facility to achieve third party accreditation to the international standard BS EN ISO/IEC 17025.

The world-class facility now conducts around 10,000 product tests annually and has recently benefited from a significant investment, which will enable double productivity. The fact that we extensively test our products give you the reassurance that they will perform in the toughest conditions. We strive to ensure that our products are compliant with the latest European requirements for construction products.



FM 767499

### ISO 9001

Simpson Strong-Tie® is an ISO 9001 registered company. ISO 9001 is an internationally-recognized quality assurance system which lets our domestic and international customers know that they can count on the consistent quality of Simpson Strong-Tie® products and services.



EMS 676246  
EMS 514057  
EMS 517722

### ISO 14001

Our Swedish, French (St. Gemme la Pleine) and UK facilities are ISO 14001 certified. This standard states the requirements for an environmental management system, and applies to the environmental aspects over which our company has control and can be expected to have an influence.



OHS 570006

### ISO 45001

Our Tamworth, UK facility is ISO 45001 certified. This certification reflects an internationally applied British Standard for occupational health and safety management systems.

To learn more about these certifications and organizations, please visit [ISO.org](http://ISO.org), [ICCSafe.org](http://ICCSafe.org) and [bsigroup.com](http://bsigroup.com).

General Information	8 - 19
Fastener Application Guide	20 - 33
Screws	34 - 61
Nails	62 - 67
Collated Nails	68 - 71
Quik Drive® Systems	72 - 95
Collated Screws for the Quik Drive System	96 - 117
Alphabetical Index	116 - 121

# Online Tools & Support for Engineers

General Information



## Technical Support

Experts in structural wood engineering, Simpson Strong-Tie is always at your side, making life easier with complete solutions, effective support, tools and advice.

With our proven track-record for service and support, peace of mind comes built-in. It's part of an engineer's DNA to plan for the unexpected. We've already spent over six decades doing just that.

We are with you every step of the way; from planning and tendering to site-build, we have people on the ground to support the process and to give further guidance. Our Technical Support team is on hand to answer your questions and provide some sound installation advice, from making sure you have the most suitable product, to the best ways to go about installing them.

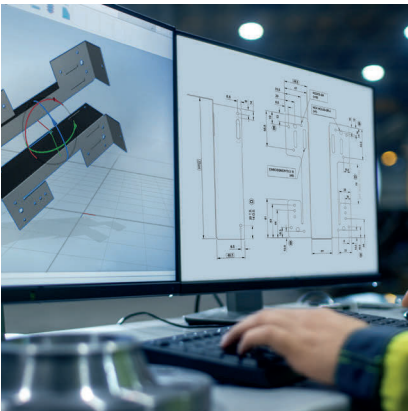

## CAD/BIM Library

Any 2D and 3D model of our Solid-Drive fasteners can be immediately integrated into building designs and design software.

We know how useful the drawings of our fasteners can be for you. That is why we offer our drawings in the following formats for free download:

- 2D / 3D DWG
- SAT
- 2D / 3D Revit
- XML
- BIM

Please note that you will need CAD software to open some of the files. You can get a free file reader at: Autodesk 'Design Review'.



## DoP/ETA Library

Our entire library of DoP (Declaration of Performance) and ETA documentation is available online. Here we provide DoP's in all main European languages.

If you know the name of the product family, you can search on each of our websites, or alternatively browse the products section as the relevant DoP and ETA file can also be found on each individual product's detail page.

Go to [strongtie.co.uk](http://strongtie.co.uk) to find out more.

## Solid Wood Fastener Dimensioning Software

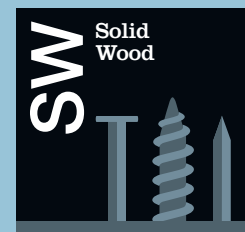

In just four simple steps, Solid Wood guides you through the calculation and selection of fastening solutions suitable for the specific wood structure at hand, all according to Eurocode 5 and our ETA.

Try Solid Wood today.

Go to [solidwood.strongtie.eu](http://solidwood.strongtie.eu)

# Fastener Features

- Head styles
- Shank styles
- Point styles

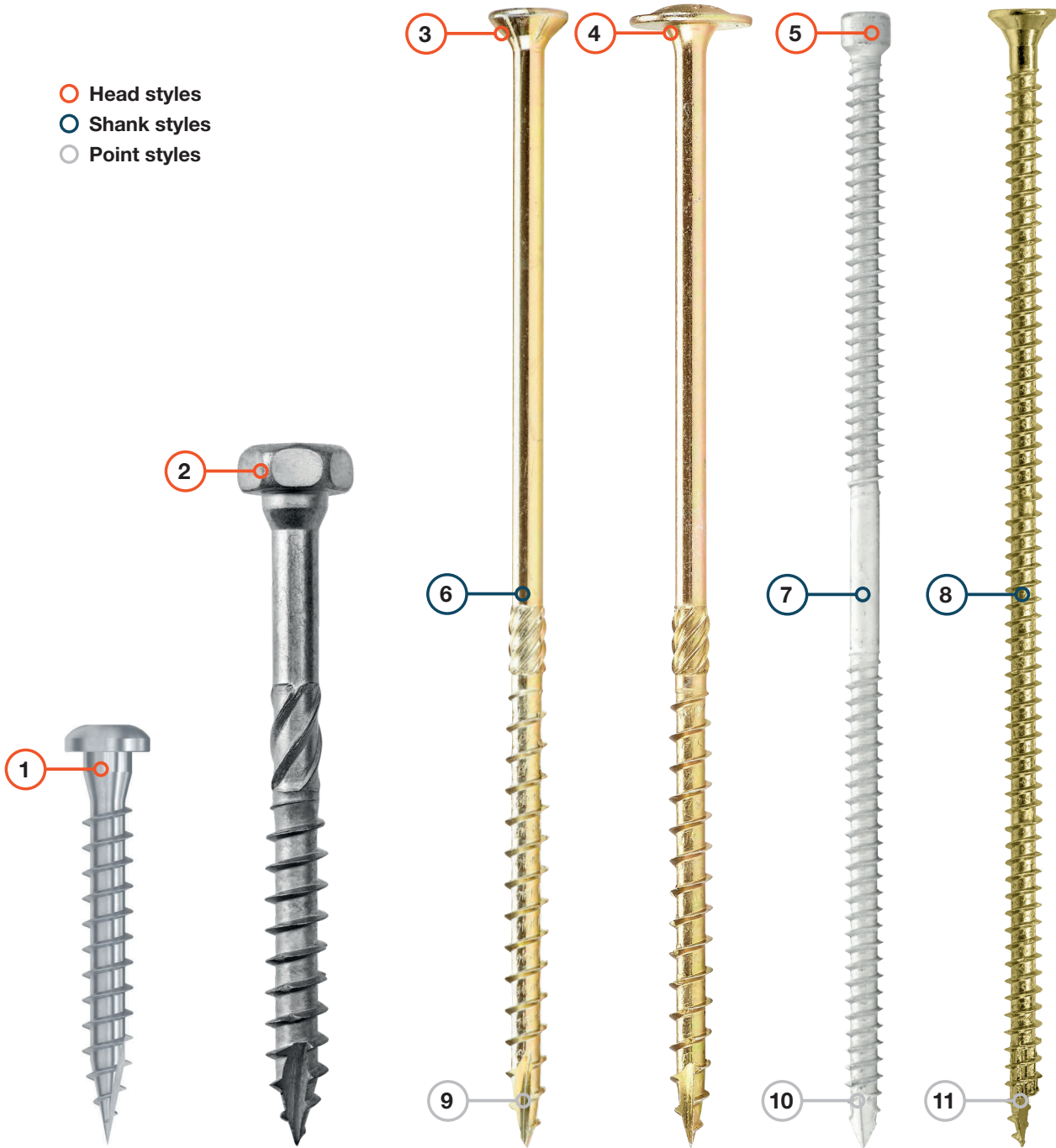

- 1 Conical shape** under the head for maximum fit in metal holes
- 2 Hex-head** with 6-lobe recess allows for the convenience of driving with either a hex-driver bit or 6-lobe driver bit
- 3 Countersunk head** with underhead nibs creates a flush finish
- 4 Washer head** creates high pull-through resistance
- 5 Small cylinder head** sinks into the wood allowing for hidden assemblies
- 6 Partial thread** with milling thread reduces the drive-in torque
- 7 Double thread** with differentiated thread pitch creates a clamping effect that pulls the wood members together
- 8 Full thread** for excellent pull-out values and high load-bearing capacities
- 9 Type 17 cut point** reduces the risk of wood splitting during the installation
- 10 Chisel point** allows for skewed installations
- 11 Half-cut point** gives low installation torque and no pre-drilling is required

# Fastener Features

General Information

## Head Styles Screws

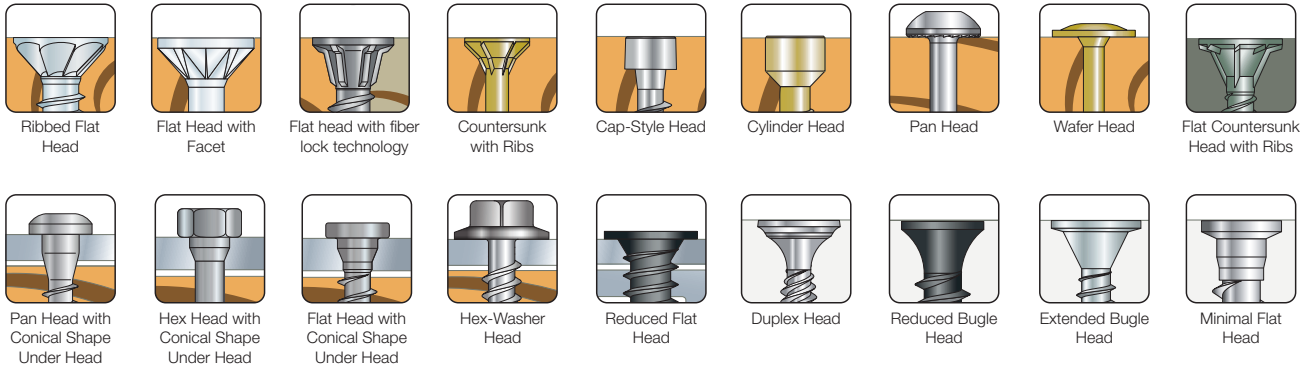

## Thread Styles Screws

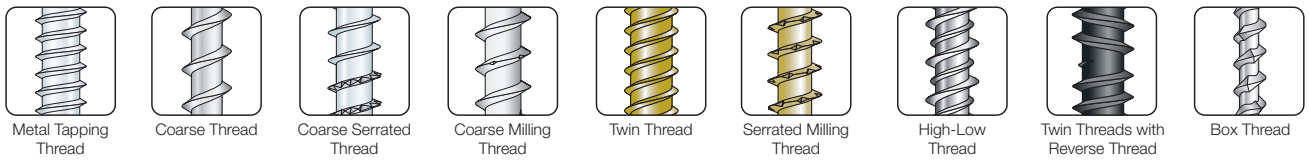

## Point Styles Screws

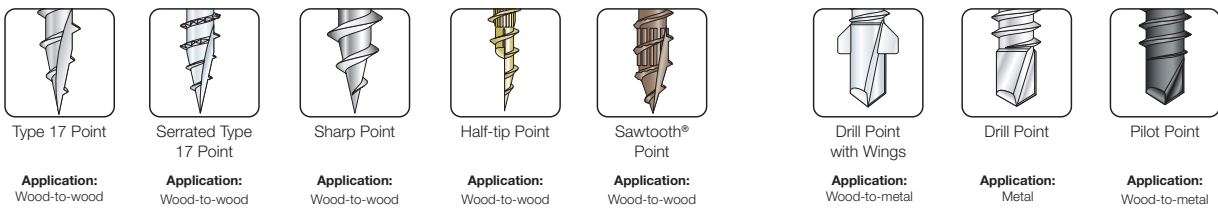

## Drive Styles Screws

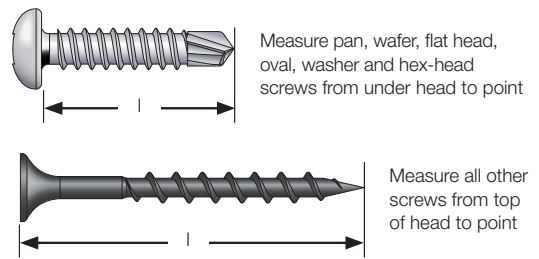

## Head Styles Nails

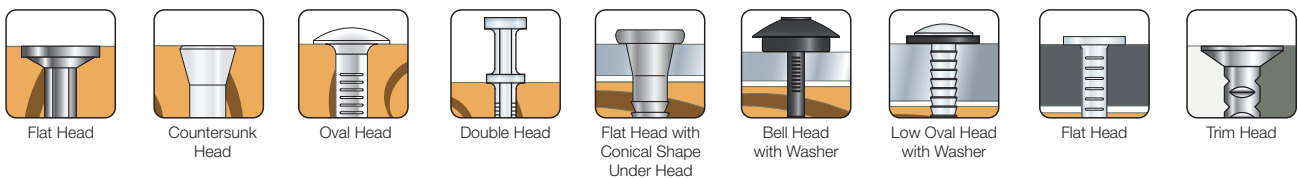

## Shank Styles Nails

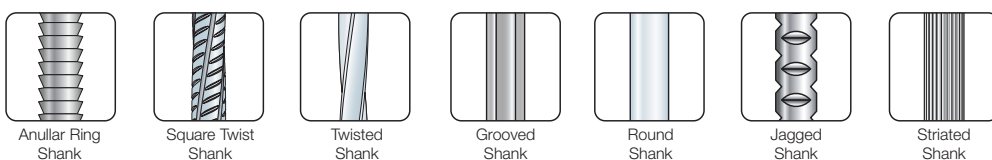

# Self-Drilling Screws

## Application

As their name implies, self-drilling screws operate on the same principles as drill bits and other cutting tools. For any cutting tool, performance is governed by cutting speed, feed rate, depth of cut and the work material itself. Therefore, installation performance of self-drilling screws can be linked to the basic cutting tool parameters:

**Point Geometry** is the designed shape of the screw's drill point.

**RPM** is the speed at which the driver motor runs while the screw is installed. This is often adjustable using a variable pull trigger or different driver motor.

**Applied Force** is a measure of the user applied force as the screw is installed. More force is not necessarily better.

**Work Material Hardness** can be viewed as a material's resistance to drilling or cutting. In most instances, the harder the work material, the more difficult it is to cut.

## Optimal Cutting Conditions by Screw Size

Screw tip type	Screw diameter	Material thickness
#2	3.5	0.9 - 2.5
	4.2	0.9 - 2.5
	4.8	0.9 - 2.8
#3	4.2	2.5 - 3.6
	4.8	2.8 - 4.4
	5.5	2.8 - 5.3
	6.1	2.8 - 5.3
#4	5.5	4.4 - 5.6
	6.1	4.4 - 5.6

\*All dimensions in mm. Total thickness of all steel including any gaps between layers.

## Special Considerations

**Drill-Point Material** is generally plain carbon steel which is less stable at high temperatures than equivalent high-speed steel (HSS) drill-bits. To reduce wear on the drill point, fasten using a drill motor rather than an impact driver or hammer drill.

**High Temperature Stability** affects how quickly the drill point fails due to the heat generated by the drilling operation. Refer to the troubleshooting guide at the end of this section for some visual examples.

**Drilling Temperature** is directly proportional to motor RPM, applied force, and work material hardness. As each value increases, so does the heat generated by the drilling operation.

**Reducing Applied Force** can increase durability and allow the drill point to penetrate thicker materials (i.e., remove more material before failing due to heat buildup).

**Reducing Motor RPM** can improve performance in harder materials by allowing the user to push harder during the drilling process and extending the life of the drill point.

## Design Features

When selecting a self-drilling screw, consider the material thicknesses and types of materials to be joined. Following are some key design features to look for when selecting suitable fasteners.

**Drill Flutes** allow drilled material to exit the hole. Completely embedded flutes can no longer remove these chips, which contain approximately 80% of the heat created by the drilling process. A buildup of this material can cause the point to over-heat and fail.

**Point Length** determines the material thickness which the screw can reliably penetrate. The unthreaded portion of the point, (pilot section), must be able to completely drill through the material before the threads engage. If the threads engage before drilling is complete, the fastener can bind and break.

**Point Wings** are used on some screws that fasten thicker materials, such as wood, to metal. The wings enlarge the hole in the fastened material, allowing the threads to pass through without contacting the fastened material. This added clearance prevents separation of the fastened material from the base metal (known as "jacking"). The wings will break away on contact with the metal before the threads engage in the metal.

## Basic Self-Drilling Screw Anatomy

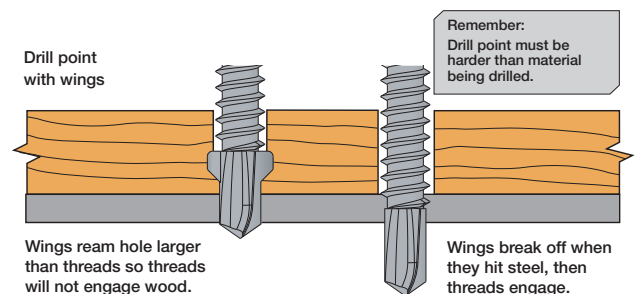
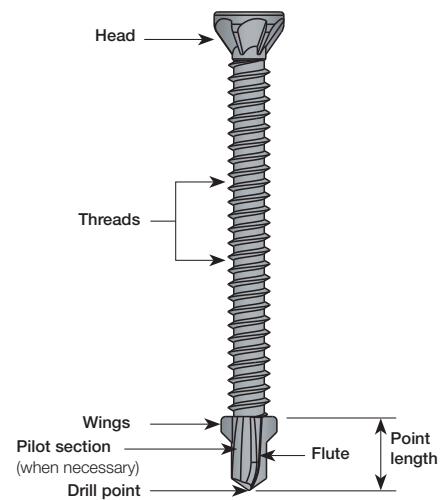

# Corrosion Information

## Materials and Coatings

General Information

For fasteners different coating are used depending of the intended use of the product.	
<b>Aluminium</b>	<b>Aluminium:</b> Can withstand rain but shouldn't be used together with other metals where there is a risk of galvanic corrosion. Certain aluminum alloys can be used outdoor together with 1.4401, 1.4404 and 1.4571 in the absence of chlorides.
<b>Brass</b>	<b>Brass:</b> Can withstand rain but shouldn't be used together with other metals where there is a risk of galvanic corrosion.
<b>Copper</b>	<b>Copper:</b> Can withstand rain but shouldn't be used together with other metals where there is a risk of galvanic corrosion.
<b>Lacquered</b>	<b>Lacquered:</b> A thin layer of paint is applied on the fastener. The corrosion performance depends on the steel quality and surface treatment of the fastener on which the paint is applied.

For fasteners different coating are used depending of the intended use of the product.	
<b>Bright Steel</b>	<b>Bright:</b> No coating is applied on the fasteners. It is only suitable for temporary fixing and indoor applications.
<b>Phosphated</b> <small>C1 acc. to EN ISO 12944-2 SC1 - 50 years acc. to EC5</small>	<b>Phosphated:</b> Products are dipped in a hot phosphoric acid and phosphates, anti-corrosion oil is added after the treatment in order to improve the corrosion resistance. It is intended for dry, indoor applications.
<b>Sheradised</b> <small>C1 acc. to EN ISO 12944-2 SC1 - 50 years acc. to EC5</small>	<b>Sheradised:</b> Products are heated up to c. 500 °C in a closed rotating drum that contains metallic zinc dust and possibly an inert filler, such as sand. It is intended for dry, indoor applications.
<b>Electro Galvanised</b> <small>C1 acc. to EN ISO 12944-2 SC1/SC2 - 50 years acc. to EC5</small>	<b>Electro Galvanised:</b> The coating system consists of an electro plated zinc base layer. Depending on the thickness of the zinc layer, it can provide corrosion resistance that is adequate for service class 1 or 2.
<b>Yellow Zinc Plated</b> <small>C2 acc. to EN ISO 12944-2 SC1/SC2 - 50 years acc. to EC5</small>	<b>Yellow Zinc Plated:</b> The coating system consists of an yellow plated zinc base layer. Depending on the thickness of the zinc layer, it can provide corrosion resistance that is adequate for service class 1 or 2.
<b>E-coat</b> <small>C2 acc. to EN ISO 12944-2 SC2 - 50 years acc. to EC5</small>	<b>Electrocoat (E-Coat):</b> Electrocoat utilizes electrical current to deposit the coating material onto the fastener. After application, the coating is oven cured. Electrocoat is intended for dry, indoor applications.
<b>AISI 410</b> <small>C3 acc. to EN ISO 12944-2 SC2 - 50 years acc. to EC5</small>	<b>AISI 410 Hardened:</b> Grade 410 stainless steels are a general-purpose martensitic stainless material containing chromium, which provides medium corrosion resistance for outdoor applications.
<b>Quik Guard® Coating</b>	<b>Quik Guard:</b> A proprietary coating that consists of an electroplated zinc base layer and a system of organic top coats intended for outdoor applications.
<b>Mechanically Galvanised</b>	<b>N2000® Mechanically Galvanised:</b> A mechanically applied proprietary zinc coating with a supplementary overcoat intended for outdoor applications.
<b>Mechanically Galvanised</b>	<b>Class 55 Mechanically Galvanised:</b> This is a mechanically-applied zinc coating with a min. average thickness of 55 microns with a supplementary overcoat. Screws with a Class 55 coating meet the requirements for use in preservative-treated and fire-retardant-treated wood as stated in 2012 and 2015 IRC.

Table continues on next page.

C-F-UK-2024 ©2024 SIMPSON STRONG-TIE COMPANY INC.



# Corrosion Information

For fasteners different coating are used depending of the intended use of the product.

<b>Protec®</b> C3 acc. to EN ISO 12944-2 SC2 - 50 years acc. to EC5	<b>Protec®:</b> Products are dipped in liquids that consists of zinc and aluminium flakes which is hardened in ovens after the spinning process. Intended for outdoor applications.
<b>Protec® +</b> C3 acc. to EN ISO 12944-2 SC2 - 50 years acc. to EC5	<b>Protec®+:</b> Products are dipped in liquids that consists of zinc and aluminium flakes which is hardened in ovens after the spinning process. Finally a layer of wax is applied. Intended for outdoor applications.
<b>Double Barrier</b> C3 acc. to EN ISO 12944-2 SC3 - 50 years acc. to EC5	<b>Double Barrier:</b> The Simpson Strong-Tie® Double Barrier coating is a proprietary coating that provides a level of corrosion resistance that is equivalent to hot-dip galvanization and is intended for outdoor applications.
<b>Impreg® +</b> C4 - 15 years acc. to EN ISO 12944-2 SC2 - 50 years acc. to EC5	<b>Impreg®+:</b> Products are dipped in liquids that consists of zinc and nickel. It provides a good corrosion performance for outdoor applications and has a low risk of galvanic corrosion together with Aluminum or Stainless Steel.
<b>Impreg®X4</b> C4 - 15 years acc. to EN ISO 12944-2 SC2 - 50 years acc. to EC5	<b>Impreg®X4:</b> The Simpson Strong-Tie® Impreg®X4 coating is a proprietary coating that provides a good level of corrosion resistance. The coating consists of several layers and is suitable for use in treated timber in outdoor applications
<b>Hot-Dip Galvanised</b> C4 acc. to EN ISO 12944-2 SC3 - 50 years acc. to EC5	<b>Hot Dip Galvanised:</b> Products are dipped in melted zinc 550-560°C, initiating a chemical reaction between the steel and the zinc. It provides a good corrosion resistance and is intended for outdoor applications.
<b>Stainless Steel</b> C4 acc. to EN ISO 12944-2 SC3 - 50 years acc. to EC5	<b>Non-Acid Proof Stainless Steel 304, 304L –A2 (1.4301, ...):</b> Types 304 stainless steels is nickel-chromium austenitic grades of stainless steel. Type 304 stainless steel is not hardened by heat treatment and is inherently non-magnetic. It provides good corrosion resistance and is suitable for outdoor applications.
<b>Stainless Steel</b> C5 acc. to EN ISO 12944-2 SC3 - 50 years acc. to EC5	<b>Acid Proof Stainless Steel 316, 316L –A4 (1.4401, 1.4404 ...):</b> Type 316 stainless steel is a nickel-chromium austenitic grade with 2-3% molybdenum. Type 316 stainless steel is not hardened by heat treatment and is inherently non-magnetic. It provides a level of corrosion protection suitable for marine and severe environments.
<b>HCR</b> CX acc. to EN ISO 12944-2 SC3 - 50 years acc. to EC5	<b>High Corrosion Resistance Stainless Steel HCR (1.4529, ...):</b> Type HCR stainless steel is developed for extremely severe corrosive environments, such as in swimming halls.

## Impreg® +

Impreg+ is an electrolytic, inorganic, surface treatment consisting of zinc and nickel. Due to the strong alloy combination the coating is very robust and suitable for corrosive environments.



Comparison test EN ISO 11997-1:2017, Cycle B, 1240 hours, low (electro galvanised), medium (Impreg+), severe (stainless steel A4).

- **C4 approved for 15 years according to EN ISO 11997-1:2017, cycle B**
- Compliant with REACH, RoHS- and ELV-directive
- Chromium (VI) free
- No galvanic corrosion in aluminium connections
- Due to the strong adhesion between the steel and the coating, Impreg+ will maintain the corrosion resistance even after installation
- Withstands temperatures up to 300° (C)

# Corrosion Information

## Understanding the Corrosion Issue

Many environments and materials can cause corrosion, including ocean salt air, fire retardants, fumes, fertilizers, preservative-treated wood, de-icing salts, dissimilar metals and more. Metal connectors, fasteners and anchors could corrode and lose load-carrying capacity when installed in corrosive environments or when installed in contact with corrosive materials.

When corrosion is caused by airborne solutions (ocean air, swimming halls, spray from a salt-treated street in winter, etc.) the metal parts can be in environments that are directly exposed to rain. They can be covered by a roof or inside the ventilated area of a facade.

The many variables present in a building environment make it impossible to accurately predict if, or when, corrosion will begin or reach a critical level. This relative uncertainty makes it crucial that specifiers and users are knowledgeable of the potential risks and

select a product suitable for the intended use. It is also prudent that regular maintenance and periodic inspections are performed, especially for outdoor applications.

It is common to see some corrosion in outdoor applications. Even stainless steel can corrode. The presence of some kinds of corrosion, e.g. white rust on zinc, does not mean that load capacity has been affected or that failure is imminent. If significant corrosion, e.g. red rust, is apparent or suspected, then a qualified engineer or inspector should inspect the framing members, fasteners and connectors. Replacement or cleansing of affected components may be appropriate. Red rust corrosion of steels will mostly carry on increasing and will cause major damage at an advanced stage.

## Galvanic Corrosion

Galvanic corrosion (also known as bimetallic corrosion, dissimilar metal corrosion or contact corrosion) may occur when dissimilar metals (e.g. galvanised mild steel and stainless steel) are in contact in a corrosive electrolyte (e.g. water containing salt, acid, etc.). When a galvanic couple forms, one of the metals in the couple becomes the anode and corrodes faster than it would all by itself, while the other becomes the cathode and corrodes slower than it would alone. For galvanic corrosion to occur, three conditions must be present:

1. Electrochemically dissimilar metals must be present,
2. These metals must be in electrical contact,
3. The metals must be exposed to an electrolyte.

The relative nobility of a material can be predicted by measuring its corrosion potential. The well-known galvanic series, (see below) lists the relative nobility of certain materials in seawater. A small anode/cathode area ratio is highly undesirable. In this case, the galvanic current is concentrated onto a small anodic area. Rapid thickness loss of the dissolving anode tends to occur under these conditions. Adverse area ratios are likely to occur with fasteners at joints.

attack, thus greater corrosion. Conversely, the rate of attack of a carbon steel connector secured by a stainless steel fastener is much slower. Prevention of bimetallic corrosion is possible by excluding an electrolyte from the connection by painting or taping over the joint. Alternatively, the two metals should be isolated from each other by painting each contact surface or using a non-metallic isolation material, typically nylon, neoprene or Teflon washers, pads, gaskets or bushes depending upon the particular application.

### Galvanic Series of Metals

Corroded end (Anode)
Magnesium, Magnesium alloys and Zinc
Aluminium, Cadmium, Iron and Steel
Lead, Tin, Nickel and Ni-Cr alloy
Brasses, Copper and Cu-Ni alloys
Nickel
Stainless Steels
Protected end (Cathode)

Carbon steel fasteners used with stainless steel connectors should be avoided because the ratio of the area between the stainless steel to carbon steel is small and the fasteners will be subject to aggressive

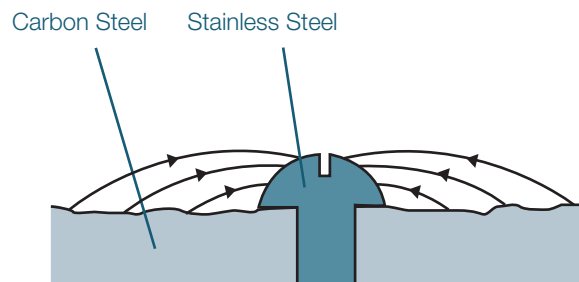

Large ANODE (Carbon Steel) area, small CATHODE (stainless steel fastener) area showing no attack on the fasteners and relatively insignificant attack of carbon steel.

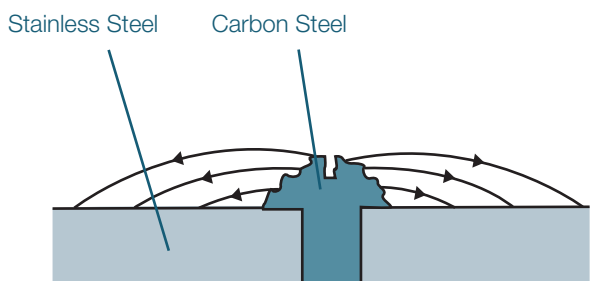

Large Cathode (Stainless Steel) area, small ANODE (carbon steel fastener) area showing no attack on the stainless steel and relatively increased attack of the fastener.

# Solid-Drive™



## High-Performance Structural Wood Fasteners.



For inclined and angled installations of our Solid-Drive screws, we recommend using the GSCREW installation guide.

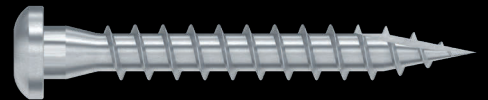

When it comes to structural fasteners, Solid-Drive is the only name you need to know. Our professional-grade screws and nails are precision engineered for strength, versatility and reliability. With innovative designs that make driving fast and easy, the entire Simpson Strong-Tie® Solid-Drive line helps keep installed costs low while meeting the highest demands. Our broad selection of fasteners is available in a wide variety of lengths for any application.



To learn more, go to [strongtie.co.uk](http://strongtie.co.uk)

**We help you build safer,  
stronger structures.**





# Fastener

## Application Guide

Solid Wood Applications . . . . .	22
CLT and Mass Timber Applications. . . . .	23
Fasteners for Simpson Strong-Tie® Connectors. . . . .	24
Drywall . . . . .	25
Mezzanine Floor. . . . .	26
Truckbeds. . . . .	26
Subfloor and Wood Sheathing Applications . . . . .	27
Decks, Docks and Boardwalks . . . . .	28
Cladding. . . . .	30
Fibre Cement & Wood Fibre Board Applications . . . . .	31
Metal to Metal . . . . .	32
Wood to Metal . . . . .	33

# Solid Wood Applications



## Screws

**SWW** Yellow Zinc Plated Structural Wood Screw

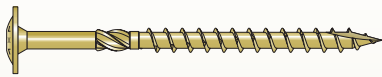

Washer head, Serrated coarse thread, Milling thread, Type 17 point, p. 41

**SWC** Yellow Zinc Plated Structural Wood Screw

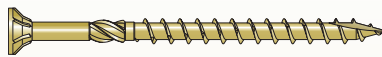

Countersunk head, Serrated coarse thread, Milling thread, p. 43

**SWD** Protec®+ Coating Structural Wood Screw



Cap-style head, Double threaded, Chisel point, p. 45

**ESCRFTZ** Yellow Zinc Plated Structural Wood Screw



ETA approved, Fully Threaded, Cap-style head, p. 47

**ESCRFT** Yellow Zinc Plated Structural Wood Screw



ETA approved, Fully Threaded, Cylinder head, p. 47

**ESCRFTC** Yellow Zinc Plated Structural Wood Screw



ETA approved, Fully Threaded, Countersunk head, p. 46

**TTUFS** Electro Galvanised Wood Screw



Countersunk head, 6 lobe drive, Type 17 point, Serrated thread, p. 49

**TTSFS** Stainless Steel A4 Wood Screw



Countersunk head, 6 lobe drive, Type 17 point, Serrated thread, p. 49

**SDW** E-Coat Structural Wood Screw



Low-profile head, Bold thread design, p. 48



# CLT and Mass Timber Applications



## Screws

**SWW** Yellow Zinc Plated Structural Wood Screw

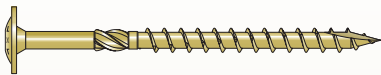

Washer head, Serrated coarse thread, Milling thread, Type 17 point, p. 41

**SWC** Yellow Zinc Plated Structural Wood Screw

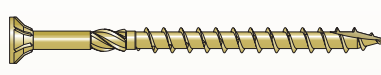

Countersunk head, Serrated coarse thread, Milling thread, Type 17 point, p. 43

**SWD** Protec®+ Coating Structural Wood Screw



Cap-style head, Double threaded, Chisel point, p. 45

**ESCRFTZ** Yellow Zinc Plated Structural Wood Screw



ETA approved, Fully Threaded, Cap-style head, p. 47

**ESCRFT** Yellow Zinc Plated Structural Wood Screw



ETA approved, Fully Threaded, Cylinder head, p. 47

**ESCRFTC** Yellow Zinc Plated Structural Wood Screw



ETA approved, Fully Threaded, Countersunk head, p. 46

**TTUFS** Electro Galvanised Countersunk Wood Screw



Countersunk head, 6 lobe drive, Type 17 point, Serrated thread, p. 49

**TTSFS** Stainless Steel A4 Countersunk Wood Screw



Countersunk head, 6 lobe drive, Type 17 point, Serrated thread, p. 49

**SDW** E-Coat Structural Wood Screw



Low-profile head, Bold thread design, p. 48

**CSA** Electro Galvanised Connector Screw

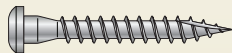

6 lobe drive, Conical shape under the head, Type 17 point, p. 36

**SSH** Impreg®+ Coating Connector Screw

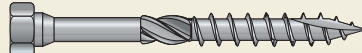

Hex head with integrated 6 lobe drive, Conical shape under the head, Type 17 point, p. 38

**CSFT** Zinc Flake Coating Connector Screw

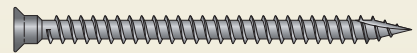

Conical shape under the head, Fully threaded, Type 17 point, p. 37



# Fasteners for Simpson Strong-Tie® Connectors

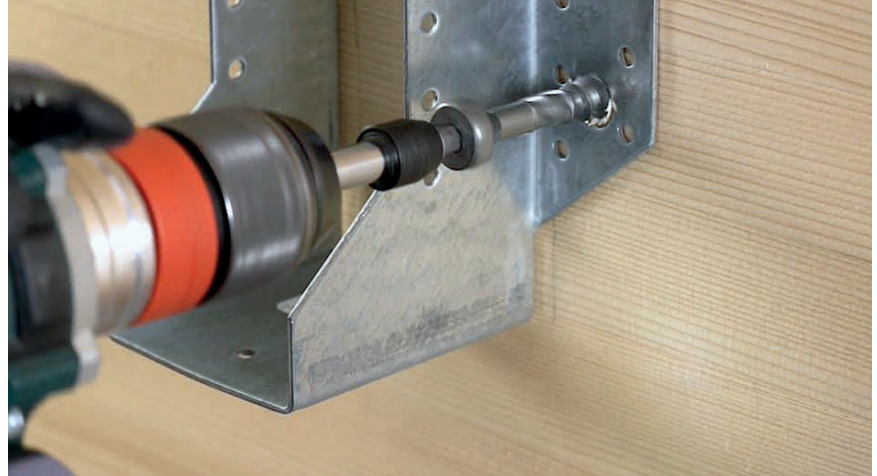

## Screws

**CSA** Electro Galvanised Connector Screw



6 lobe drive, Conical shape under the head, Type 17 point, p. 36

**SSH** Impreg®+ Coating Connector Screw

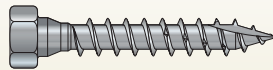

Hex head with integrated 6 lobe drive, Conical shape under the head, Type 17 point, p. 38

## Collated Screws for Quik Drive

**CSA-T** Electro Galvanised Collated Connector Screw

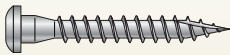

6 lobe drive, Conical shape under the head, Type 17 point, p. 106

## Nails

**CNA** Electro Galvanised Connector Nail

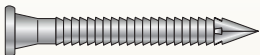

Conical shape under the head, Annular ring thread, p. 62

**CNA-G** Hot Dip Galvanised Connector Nail



Conical shape under the head, Annular ring thread, p. 62

**CNA-S** Stainless steel A4 Connector Nail



Conical shape under the head, Annular ring thread, p. 63

**N3.75** Sheradised or Hot Dip Galvanised Square Twist Nail



Flat head, Square twist profile, p. 63



# Fasteners for Simpson Strong-Tie® Connectors

## Collated Nails

**CNAPC34** Electro Galvanised  
Collated Connector Nail



Paper strip 34°, Conical shape under the head, Annular ring thread, p. 68

## Drywall

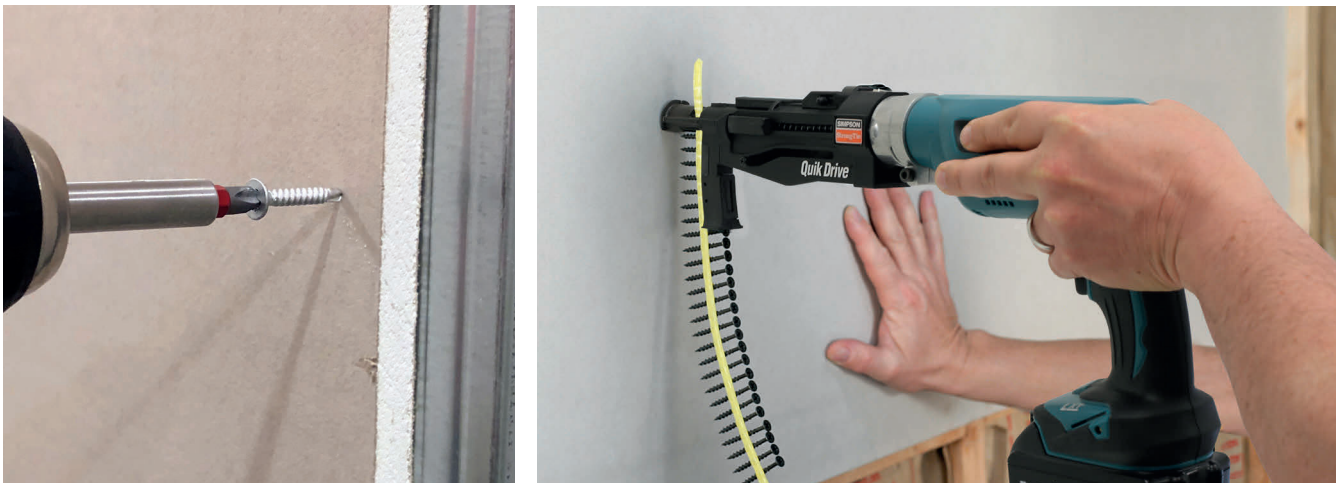

## Collated Screws for Quik Drive

**DWC** Phosphated  
Collated Drywall to Wood Screw



Bugle head, Sharp point with coarse thread, p. 96

**DWF** Phosphated  
Collated Drywall to Steel Screw



Bugle head, Sharp point with fine thread, p. 97

**RDWF** Phosphated  
Collated Drywall to Wood and Steel Screw



Reduced bugle head, Sharp point, Twin thread with reverse thread, p. 99

**DWHL** Phosphated  
Collated Drywall to Wood and Steel Screw



Bugle head, Sharp point with High-low thread, p. 98

**DWFS** Yellow Zinc Plated  
Collated Drywall to Steel Screw



Bugle head, Drill point, p. 98

**RDPF** Phosphated  
Diamond Board® to Wood & Steel Screw



Conical shape under the head, Sharp point, Fine thread with reverse thread, p. 99

**RTFSD** Phosphated  
Hard-Drywall to Steel Screw



Reduced bugle head, Drill point, Fine thread with reverse thread, p. 99

# Mezzanine Floor

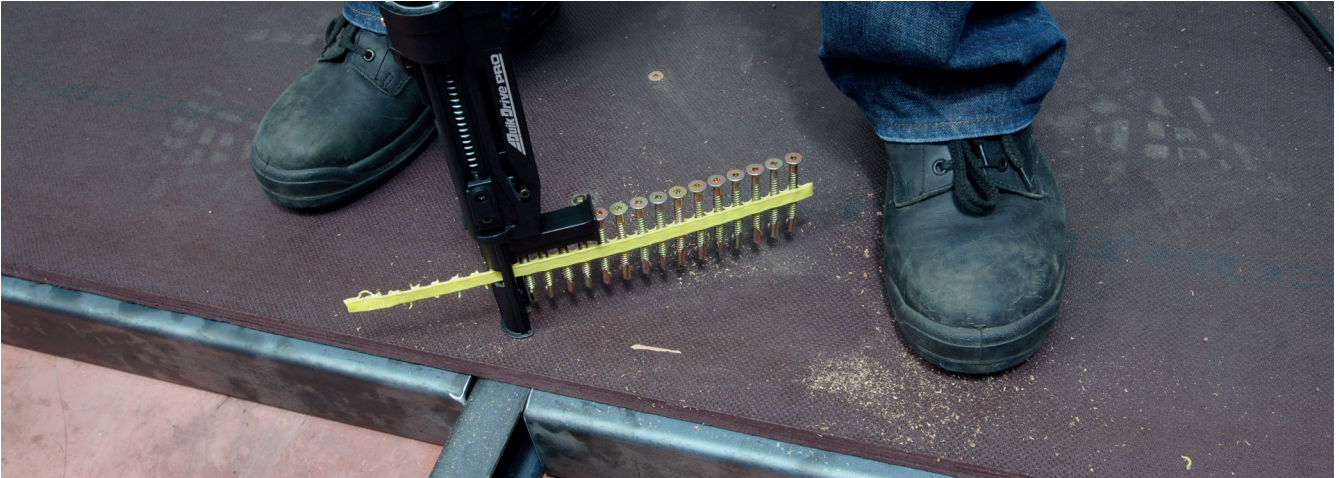

## Collated Screws for Quik Drive

**FHSD** Electro Galvanised  
Collated Mezzanine Floor Screw



Drill point, Ribbed head, p. 102

**CBSDQ** Quik Guard® Coating  
Collated Mezzanine to Steel Screw



Ribbed head, Drill point with wings,  
p. 103

# Truckbeds



## Collated Screws for Quik Drive

**TBG** N2000 Mechanically Galvanised  
Collated Truck Bed Screw



Ribbed Head, Winged drill point,  
p. 105

# Subfloor and Wood Sheathing Applications



## Collated Screws for Quik Drive

**WSV** Yellow Zinc Plated  
Collated Subfloor Screw

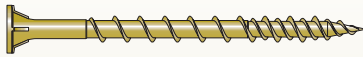

Flat head with ribs, Variable thread,  
Sharp point, p. 107

**CHB** Electro Galvanised  
Collated Wood Fibre to Wood Screw

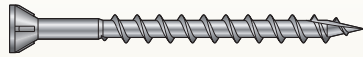

Flat head with ribs, Coarse thread,  
Type 17 point, p. 109

**MTH** Yellow Zinc Plated  
Collated Subfloor Screw



Sharp point with twin lead thread,  
p. 100

**PCULP** Yellow Zinc Plated  
Standard Seam Roofing Screw



Ultra low profile pancake head,  
Fine thread, Type 17 point, p. 105

**WSC** Yellow Zinc Plated  
Wood Flooring Screw



Flat head, Coarse thread,  
Sharp point, p. 108

## Collated Nails

**RSN34G** Hot Dip Galvanised  
Collated Framing Nail

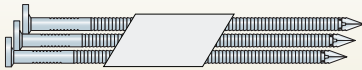

Paper tape 34°, Off-set round head,  
Ring shank, p. 69

**RSND34G** Hot Dip Galvanised  
Collated Framing Nail

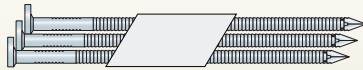

Paper tape 34°, Clipped D-head,  
Ring shank, p. 69

# Decks, Docks and Boardwalks



## Screws

**TTSFS** Stainless Steel A4  
Countersunk Wood Screw



Countersunk head, 6 lobe drive, Type 17 point, Serrated thread, p. 49

**DSPROA4** Stainless Steel A4  
Hardwood Decking Screw



6 lobe drive, Double threaded, Chisel point, p. 54

**TTFA4** Stainless Steel A4  
Decking Screw



Countersunk with ribs, Coarse thread, Type 17 point, p. 52

**DSIX4** Impreg® X4 Coating  
Decking Screw

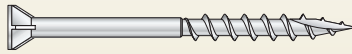

Countersunk with ribs, Coarse thread, Type 17 point, p. 53

# Decks, Docks and Boardwalks

## Collated Screws for Quik Drive

**SS3DSC** Stainless Steel A4 and A2  
Collated Decking Screw



Sharp point, Coarse thread, p. 111

**SSDTH** Stainless Steel A2  
Collated Decking Screw



Sharp point, Box thread, p. 110

**SSBFHSD** Stainless Steel A4  
Collated Wood to Metal Screw



Countersunk, Winged point, p. 112

**SSDHPD** Stainless Steel A2  
Collated Hardwood Decking Screw

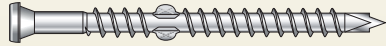

Compact head, Wings on the shaft,  
p. 112

**DTHQ** Quik Guard Coating  
Collated Wood Screw



Trim Head, Type 17 point, p. 111

## Nails

**ARA4** Stainless Steel A4  
Ring Shank Nail



Low oval head, Ring shank,  
p. 64

**CNA-S** Stainless Steel A4  
Connector Nail



Conical shape under the head, Annular  
ring thread, p. 63

**CNA-G** Hot Dip Galvanised  
Connector Nail



Conical shape under the head,  
Annular ring thread, p. 62

# Cladding



## Screws

**CLSA4** Stainless A4  
Facade Screw



Flat head, Double threaded, Type 17  
point, p. 54

## Collated Screws for Quik Drive

**SSDTH** Stainless Steel A2  
Collated Cladding Screw



Sharp point, Box thread, p. 110

**CLSZN-E** Impreg®+ Coating  
Collated Facade Screw



Flat head, Double threaded, Type 17  
point, p. 110

## Nails

**CLNA4** Stainless Steel A4  
Cladding Nail



Flat head, 60 degree diamond point,  
Ring shank, p. 65

**CLNG** Hot Dip Galvanised  
Cladding Nail



Flat head, 60 degree diamond point,  
Ring shank, p. 65

# Fibre Cement & Wood Fibre Board Applications



## Screws

**FBCS Impreg®+ Coating**  
Fibre Cement Screw



Countersunk head with ribs, Sharp point, p. 57

**FBCB Impreg®+ Coating**  
Fibre Cement Screw



Countersunk head with ribs, Drill point, p. 58

## Collated Screws for Quik Drive

**MTH Phosphated**  
Collated Underlayment to Wood Screw



Square drive, High-low thread, Sharp point, p. 100

**WSHL Phosphated**  
Collated Underlayment to Wood Screw



Rimmed flat head with nibs, Hi-lo threads, Sharp point, p. 101

**CBSDQ Quik Guard® Coating**  
Collated Fibre Cement Board to Steel Screw



Ribbed head, Drill point with wings, p. 103

**FBCS-E Impreg®+ Coating**  
Collated Fibre Cement Screw

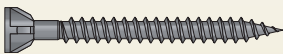

Countersunk head with ribs, Sharp point, p. 104

**FBCB-E Impreg®+ Coating**  
Collated Fibre Cement Screw



Countersunk head with ribs, Drill point, p.104

**CB3BLGHL C3 Mechanically Galvanised Coating**  
Fibre Cement Board to Wood Screw



Ribbed head, Sharp point with high-low thread, p.103

# Metal to Metal



## Screws

**SSP** Phosphated  
Steel to Steel Screw



Metal tapping thread, Sharp point  
p. 55

**FSM** Phosphated  
Steel to Steel Screw

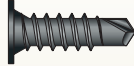

Metal tapping thread, Drill point,  
p. 55

**HS** Electro Galvanised  
Steel to Steel Screw

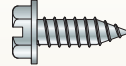

Metal tapping thread, Sharp point,  
p. 56

**HSB** Electro Galvanised  
Steel to Steel Screw



Metal tapping thread, Drill point,  
p. 56

## Collated Screws for Quik Drive

**X** Electro Galvanised  
Collated Self Drilling Metal Screw



8 mm hex head, Drill point, Hex washer  
head, p. 114

**FPHSD** Electro Galvanised  
Collated Steel Framing Screw

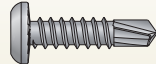

Flat head, Drill point with fine thread,  
p. 114

**PHSD** Electro Galvanised  
Collated Steel Framing Screw

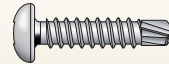

Pan head, Drill point with fine thread,  
p. 114



# Wood to Metal



## Collated Screws for Quik Drive

**CBSDQ** Quik Guard® Coating  
Collated Wood to Metal Screw

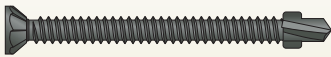

Ribbed head, Drill point with wings,  
p. 103

**FHSD** Electro Galvanised  
Collated Wood to Metal Screw



Drill point, Ribbed head, p. 102

**TBG** N2000 Mechanically Galvanised  
Collated Truck Bed Screw



Ribbed Head, Winged drill point , p. 105



SSH Hex Head Connector Screw

**Precision engineered to  
meet any demand.**

# Screws



<b>Connector Screws</b>	
CSA CONNECTOR Screw . . . . .	36
CSFT Full Thread CONNECTOR Screw . . . . .	37
SSH Hex-Head CONNECTOR Screw . . . . .	38
<b>Structural Wood Screws</b>	
SWW Structural Washer Head WOOD Screw . . . . .	41
SWC Structural Countersunk WOOD Screw . . . . .	43
SWD Structural Double Threaded WOOD Screw . . . . .	45
ESCRFTC Fully Threaded Countersunk WOOD Screw . . . . .	46
ESCRFTZ/ESCRFT Fully Threaded WOOD Screw . . . . .	47
SDW Structural WOOD Screw . . . . .	48
TTUFS/TTSFS Countersunk WOOD Screw . . . . .	49
<b>Decking Screws</b>	
TTFA4 DECKING Screw, Stainless A4 . . . . .	52
DSIX4 DECKING Screw, Impreg® X4 . . . . .	53
DSPROA4 HARDWOOD DECKING Screw, Stainless . . . . .	54
<b>Facade Screws</b>	
CLSA4 Wood FACADE Screw . . . . .	54
<b>Assembly Screws</b>	
SSP/FSM Steel to STEEL Screws . . . . .	55
HS/HSB Steel to STEEL Screws . . . . .	56
<b>Board Screws</b>	
FBCS FIBRE CEMENT Screw . . . . .	57
FBCB FIBRE CEMENT Screw, Drill point . . . . .	58
<b>Parts and Accessories</b> . . . . .	59

# Connector Screws

## Solid-Drive™ CSA CONNECTOR Screw



### Simpson Strong-Tie Connectors to Wood

The Solid-Drive™ CSA connector screw is developed for installing of Simpson Strong-Tie® connectors to wood, in order to obtain the published load bearing capacities.

The conical shape under the head secures full contact to the connector, which increases the transfer of force. A fixed connection with larger cross-bearing capacity than for standard screws is obtained. The 6 lobe recess helps to fix the screw during insertion.

**Features:**

- ETA approved (ETA-04/0013)
- UKTA approved (UKTA-22/6512)
- Conical shape under the head for maximum fit in metal holes
- Type 17 cut point reduces the risk of wood splitting during the installation
- Deep 6-lobe recess provides improved control and greater bit life

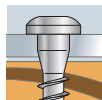

**Electro Galvanised**  
 C1 acc. to EN ISO 12944-2  
 SC2 - 50 years acc. to EC5

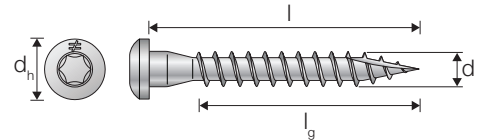

### CSA Electro Galvanised

References	Dimensions [mm]				Bit	Box
	d	l	d <sub>h</sub>	l <sub>g</sub>		
CSA4.0X30	4.0	30	7.3	24	T-15	250
CSA5.0X25	5.0	25	8.3	19	T-20	250
CSA5.0X35-R	5.0	35	8.3	29	T-20	25
CSA5.0X35*	5.0	35	8.3	29	T-20	250
CSA5.0X35-HV	5.0	35	8.3	29	T-20	1500
CSA5.0X40-R	5.0	40	8.3	34	T-20	25
CSA5.0X40*	5.0	40	8.3	34	T-20	250
CSA5.0X40-HV	5.0	40	8.3	34	T-20	1500
CSA5.0X50*	5.0	50	8.3	34	T-20	250
CSA5.0X80	5.0	80	8.3	44	T-20	200

\* Available as collated screws for the Quik Drive® system, see page 106.

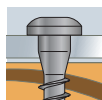

**Impreg®+**  
 C4 - 15 years acc. to EN ISO 12944-2  
 SC2 - 50 years acc. to EC5

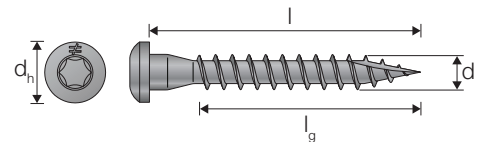

### CSA-Z Impreg®+ Coating

References	Dimensions [mm]				Bit	Box
	d	l	d <sub>h</sub>	l <sub>g</sub>		
CSA5.0X35Z	5.0	35	8.3	29	T-20	250
CSA5.0X35Z-HV	5.0	35	8.3	29	T-20	1500
CSA5.0X40Z	5.0	40	8.3	34	T-20	250
CSA5.0X40Z-HV	5.0	40	8.3	34	T-20	1500
CSA5.0X50Z	5.0	50	8.3	44	T-20	250

# Connector Screws

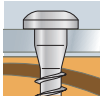

**Stainless Steel**  
C5 acc. to EN ISO 12944-2  
SC3 - 50 years acc. to EC5

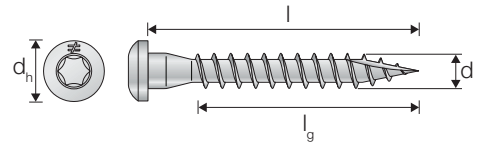

## CSA-S Stainless Steel A4

References	Dimensions [mm]				Bit	
	d	l	d <sub>h</sub>	l <sub>g</sub>		
CSA5.0X25S	5.0	25	8.3	19	T-20	250
CSA5.0X35S	5.0	35	8.3	29	T-20	250
CSA5.0X40S	5.0	40	8.3	34	T-20	250

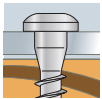

**Stainless Steel HCR**  
CX acc. to EN ISO 12944-2  
SC3 - 50 years acc. to EC5

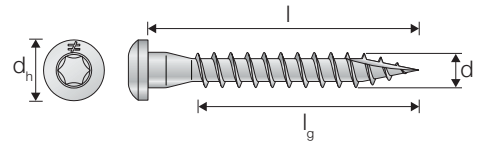

## CSA-HCR High-Corrosion Resistance Steel

References	Dimensions [mm]				Bit	
	d	l	d <sub>h</sub>	l <sub>g</sub>		
CSA5.0X40HCR	5.0	40	8.3	34	T-20	100

For additional technical data, such as load-bearing capacities, installation data and more, visit our website [www.strongtie.co.uk](http://www.strongtie.co.uk).

# Solid-Drive™ CSFT Full Thread CONNECTOR Screw



### Simpson Strong-Tie CCS Connectors to Wood

CSFT connector screw is designed for steel to wood connections and load rated together with specific Simpson Strong-Tie connectors. The new head shape ensures a good fit in the connector and the full thread increases the load bearing capacity. The flat head makes it possible to get a flush surface after installation.

**Features:**

- CE Marked (EN14592)
- Fully threaded
- 6 lobe drive
- Special head shape designed for SST connectors

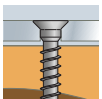

**Zinc Flake Coating**  
C2 acc. to EN ISO 12944-2  
SC2 - 50 years acc. to EC5

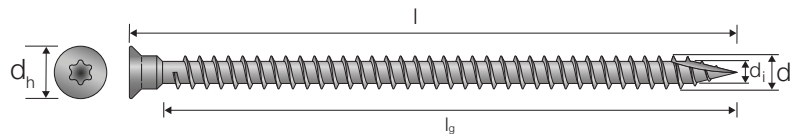

## CSFT Zinc Flake Coating

References	Item code	Dimensions [mm]				Bit	
		d	l	d <sub>h</sub>	l <sub>g</sub>		
CSFT5.0X70	77308	5.0	70	8.5	Full Thread	T-20	100
CSFT6.0X85	77309	6.0	85	9.5	Full Thread	T-25	100
CSFT6.0X110	77310	6.0	110	9.5	Full Thread	T-25	100

For additional technical data, such as load-bearing capacities, installation data and more, visit our website [www.strongtie.co.uk](http://www.strongtie.co.uk).

# Connector Screws

## Solid-Drive™ SSH Hex-Head CONNECTOR Screw



### Simpson Strong-Tie Connectors to Wood

The Solid-Drive® SSH hex-head screw is a structural fastener designed for cross-laminated timber (CLT), glulam construction and general metal to wood applications.

These partially-threaded, sturdy 6.0, 8.0, 10.0 and 12.0 mm diameter structural fasteners are designed to provide excellent connection strength, especially when connecting steel plate or angle connectors to wood. The unique head combining hex and torx allows for the convenience of driving with either a hex-driver bit or 6-lobe driver bit. The SSH screws are Impreg-coated for increased corrosion protection. They have a robust knurled shank and type-17 cut-point for fast starts and low-torque driving.

#### Features:

- ETA approved (ETA-21/0670)
- UKTA approved (UKTA-22/6514)
- Conical shape under the head for maximum fit in metal holes
- Serrated coarse thread and milling thread for low installation torque and excellent pull-out values
- Type 17 cut point reduces the risk of wood splitting during the installation
- Hex-head with 6-lobe recess allows for the convenience of driving with either a hex-driver bit or 6-lobe driver bit
- Head stamp includes length in mm for inspection

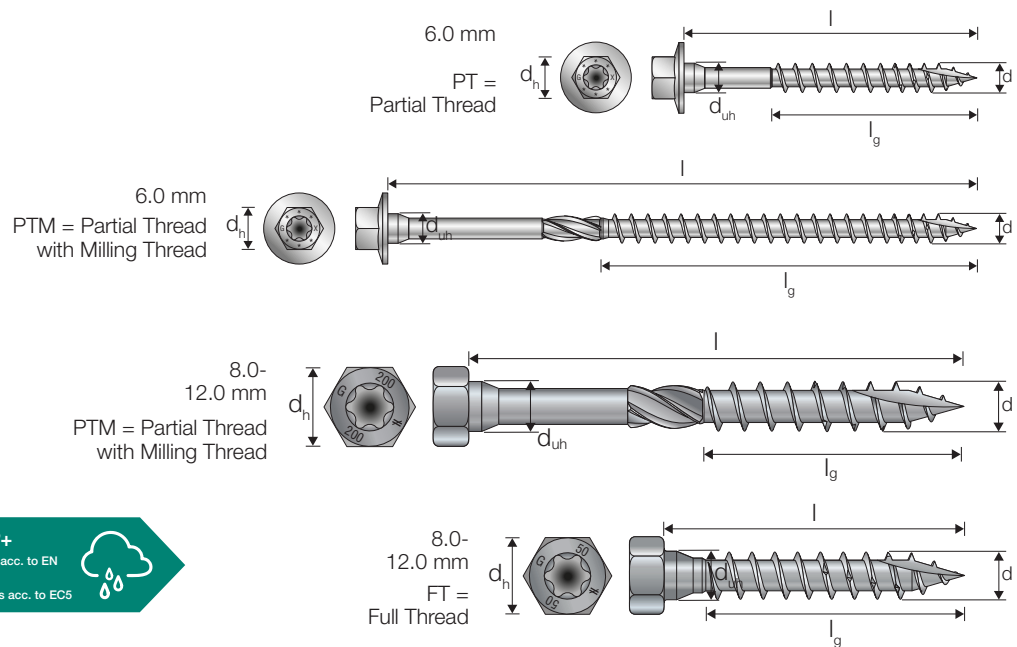

### SSH Impreg®+ Coating

References	Item code	Dimensions [mm]				Thread	Bit	8	100
		d / d <sub>uh</sub>	l	d <sub>h</sub>	l <sub>g</sub>				
SSH6.0X40	77183	6.0	40	10	23	PT	T-30 / SW-10	8	-
SSH6.0X40	75128	6.0	40	10	23	PT	T-30 / SW-10	-	100
SSH6.0X50	77184	6.0	50	10	33	PT	T-30 / SW-10	8	-
SSH6.0X50	75129	6.0	50	10	33	PT	T-30 / SW-10	-	100
SSH6.0X60	75130	6.0	60	10	42	PT	T-30 / SW-10	-	100
SSH6.0X75	75131	6.0	75	10	42	PTM	T-30 / SW-10	-	100
SSH6.0X90	75132	6.0	90	10	42	PTM	T-30 / SW-10	-	100
SSH6.0X120	75133	6.0	120	10	75	PTM	T-30 / SW-10	-	100

# Connector Screws

## SSH Impreg®+ Coating

References	Item code	Dimensions [mm]				Thread	Bit		
		d / d <sub>uh</sub>	l	d <sub>h</sub>	l <sub>g</sub>				
SSH8.0X40	77185	8.0	40	13	Full Thread	FT	T-40 / SW-13	8	-
SSH8.0X40	75134	8.0	40	13	Full thread	FT	T-40 / SW-13	-	50
SSH8.0X50	77186	8.0	50	13	Full Thread	FT	T-40 / SW-13	8	-
SSH8.0X50	75135	8.0	50	13	Full thread	FT	T-40 / SW-13	-	50
SSH8.0X60	77187	8.0	60	13	42	PT	T-40 / SW-13	8	-
SSH8.0X60	75136	8.0	60	13	42	PT	T-40 / SW-13	-	50
SSH8.0X80	77188	8.0	80	13	42	PTM	T-40 / SW-13	8	-
SSH8.0X80	75137	8.0	80	13	42	PTM	T-40 / SW-13	-	50
SSH8.0X90	77189	8.0	90	13	42	PTM	T-40 / SW-13	8	-
SSH8.0X90	75138	8.0	90	13	42	PTM	T-40 / SW-13	-	50
SSH8.0X100	77190	8.0	100	13	55	PTM	T-40 / SW-13	8	-
SSH8.0X100	75139	8.0	100	13	55	PTM	T-40 / SW-13	-	50
SSH8.0X120	75140	8.0	120	13	85	PTM	T-40 / SW-13	-	50
SSH8.0X140	75141	8.0	140	13	85	PTM	T-40 / SW-13	-	50
SSH8.0X160	75142	8.0	160	13	110	PTM	T-40 / SW-13	-	50
SSH8.0X180	75143	8.0	180	13	110	PTM	T-40 / SW-13	-	50
SSH8.0X200	75144	8.0	200	13	110	PTM	T-40 / SW-13	-	50
SSH8.0X240	75145	8.0	240	13	110	PTM	T-40 / SW-13	-	50
SSH8.0X260	75146	8.0	260	13	110	PTM	T-40 / SW-13	-	50
SSH8.0X280	75147	8.0	280	13	110	PTM	T-40 / SW-13	-	50
SSH8.0X300	75148	8.0	300	13	110	PTM	T-40 / SW-13	-	50
SSH10.0X40	77191	10.0	40	15	Full Thread	FT	T-40 / SW-15	8	-
SSH10.0X40	75149	10.0	40	15	Full thread	FT	T-40 / SW-15	-	50
SSH10.0X50	77192	10.0	50	15	Full Thread	FT	T-40 / SW-15	4	-
SSH10.0X50	75150	10.0	50	15	Full thread	FT	T-40 / SW-15	-	50
SSH10.0X60	77193	10.0	60	15	42	PT	T-40 / SW-15	4	-
SSH10.0X60	75151	10.0	60	15	42	PT	T-40 / SW-15	-	50
SSH10.0X80	77194	10.0	80	15	42	PTM	T-40 / SW-15	4	-
SSH10.0X80	75152	10.0	80	15	42	PTM	T-40 / SW-15	-	50
SSH10.0X90	77195	10.0	90	15	42	PTM	T-40 / SW-15	4	-
SSH10.0X90	75153	10.0	90	15	42	PTM	T-40 / SW-15	-	50
SSH10.0X100	77197	10.0	100	15	55	PTM	T-40 / SW-15	4	-
SSH10.0X100	75154	10.0	100	15	55	PTM	T-40 / SW-15	-	50
SSH10.0X120	77198	10.0	120	15	85	PTM	T-40 / SW-15	4	-
SSH10.0X120	75155	10.0	120	15	85	PTM	T-40 / SW-15	-	50
SSH10.0X140	75156	10.0	140	15	85	PTM	T-40 / SW-15	-	50
SSH10.0X160	75157	10.0	160	15	110	PTM	T-40 / SW-15	-	50
SSH10.0X180	75158	10.0	180	15	110	PTM	T-40 / SW-15	-	50
SSH10.0X200	75159	10.0	200	15	110	PTM	T-40 / SW-15	-	50
SSH10.0X240	75160	10.0	240	15	125	PTM	T-40 / SW-15	-	50
SSH10.0X280	75161	10.0	280	15	125	PTM	T-40 / SW-15	-	50
SSH12.0X60	75162	12.0	60	17	Full thread	FT	T-40 / SW-17	-	25
SSH12.0X80	75163	12.0	80	17	42	PTM	T-40 / SW-17	-	25
SSH12.0X90	75164	12.0	90	17	42	PTM	T-40 / SW-17	-	25
SSH12.0X100	75165	12.0	100	17	55	PTM	T-40 / SW-17	-	25
SSH12.0X120	75166	12.0	120	17	85	PTM	T-40 / SW-17	-	25
SSH12.0X140	75167	12.0	140	17	85	PTM	T-40 / SW-17	-	25
SSH12.0X160	75168	12.0	160	17	110	PTM	T-40 / SW-17	-	25
SSH12.0X180	75169	12.0	180	17	110	PTM	T-40 / SW-17	-	25
SSH12.0X200	75170	12.0	200	17	110	PTM	T-40 / SW-17	-	25

C-F-UK-2024 ©2024 SIMPSON STRONG-TIE COMPANY INC.

# Connector / Structural Wood Screws

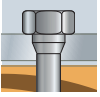

**Stainless Steel**  
C5 acc. to EN ISO 12944-2  
SC3 - 50 years acc. to EC5

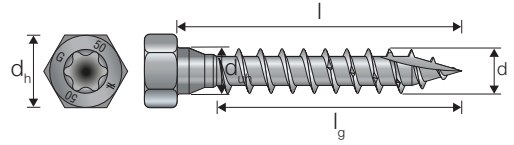

## SSH Stainless Steel A4

References	Item code	Dimensions [mm] [d <sub>h</sub> ]				Thread	Bit	
		d / d <sub>uh</sub>	l	d <sub>h</sub>	l <sub>g</sub>			
SSH10.0X40A4	77282	10.0	40	15	Full thread	FT	T-40 / SW-15	20

For additional technical data, such as load-bearing capacities, installation data and more, visit our website [www.strongtie.co.uk](http://www.strongtie.co.uk).



# Structural Wood Screws

## Solid-Drive™

## SWW Structural Washer Head WOOD Screw



### Structural Timber to Timber Connections Including Glulam, CLT and General Timber Applications

SWW are washer-head structural screws designed for load-bearing wood structures. The SWW screws have a milling thread to allow for smooth driving of the shank. The large washer head gives high head pull-through resistance while allowing the wood members to close up firmly.

These partially-threaded, 6.0, 8.0 and 10.0 mm diameter structural fasteners are designed to pull structural members together with superb holding power and excellent load capacity. The large washer head provides extreme pull-through resistance while allowing the wood members to close up firmly. Pre-drilling is not typically required. SWW screws are yellow zinc plated for standard interior and dry applications only.

#### Features:

- ETA approved (ETA-21/0670) / UKTA approved (UKTA-22/6514)
- Washer head creates high pull-through resistance
- Type 17 cut point reduces the risk of wood splitting during the installation
- Heavy-duty thread and shank provides strength and stability
- Milling thread reduces the installation torque



#### Yellow Zinc Plated

C2 acc. to EN ISO 12944-2  
SC2 - 50 years acc. to EC5

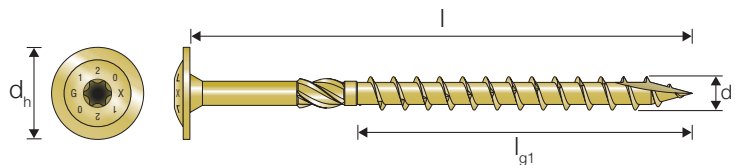

### SWW Yellow Zinc Plated

References	Item code	Dimensions [mm]				Bit	
		d	l	d <sub>h</sub>	l <sub>g</sub>		
SWW6.0X60	75382	6.0	60	14	42	T-30	50
SWW6.0X80	75383	6.0	80	14	50	T-30	50
SWW6.0X100	75384	6.0	100	14	70	T-30	50
SWW6.0X120	75385	6.0	120	14	70	T-30	50
SWW6.0X140	75386	6.0	140	14	70	T-30	50
SWW6.0X160	75387	6.0	160	14	70	T-30	50
SWW6.0X180	75388	6.0	180	14	70	T-30	50
SWW6.0X200	75389	6.0	200	14	70	T-30	50
SWW6.0X220	75390	6.0	220	14	70	T-30	50
SWW6.0X240	75391	6.0	240	14	70	T-30	50
SWW6.0X260	75392	6.0	260	14	70	T-30	50
SWW6.0X280	75393	6.0	280	14	70	T-30	50
SWW6.0X300	75394	6.0	300	14	70	T-30	50
SWW8.0X80	75395	8.0	80	22.2	50	T-40	50
SWW8.0X100	75396	8.0	100	22.2	50	T-40	50
SWW8.0X120	75397	8.0	120	22.2	80	T-40	50
SWW8.0X140	75398	8.0	140	22.2	80	T-40	50
SWW8.0X160	75399	8.0	160	22.2	80	T-40	50
SWW8.0X180	75400	8.0	180	22.2	80	T-40	50
SWW8.0X200	75401	8.0	200	22.2	80	T-40	50
SWW8.0X220	75402	8.0	220	22.2	80	T-40	50
SWW8.0X240	75403	8.0	240	22.2	80	T-40	50
SWW8.0X260	75404	8.0	260	22.2	80	T-40	50
SWW8.0X280	75405	8.0	280	22.2	80	T-40	50
SWW8.0X300	75406	8.0	300	22.2	80	T-40	50
SWW8.0X320	75407	8.0	320	22.2	80	T-40	50

# Structural Wood Screws

## SWW Yellow Zinc Plated

References	Item code	Dimensions [mm]				Bit	
		d	l	d <sub>h</sub>	l <sub>g</sub>		
SWW8.0X340	75408	8.0	340	22.2	80	T-40	50
SWW8.0X360	75409	8.0	360	22.2	80	T-40	50
SWW8.0X380	75410	8.0	380	22.2	80	T-40	50
SWW8.0X400	75411	8.0	400	22.2	80	T-40	50
SWW10.0X100	76912	10.0	100	25.9	80	T-40	25
SWW10.0X120	76913	10.0	120	25.9	80	T-40	25
SWW10.0X140	76914	10.0	140	25.9	80	T-40	25
SWW10.0X160	75412	10.0	160	25.9	80	T-40	25
SWW10.0X180	75413	10.0	180	25.9	80	T-40	25
SWW10.0X200	75414	10.0	200	25.9	80	T-40	25
SWW10.0X220	75415	10.0	220	25.9	80	T-40	25
SWW10.0X240	75416	10.0	240	25.9	80	T-40	25
SWW10.0X260	75417	10.0	260	25.9	80	T-40	25
SWW10.0X280	75418	10.0	280	25.9	80	T-40	25
SWW10.0X300	75419	10.0	300	25.9	80	T-40	25
SWW10.0X320	75420	10.0	320	25.9	80	T-40	25
SWW10.0X340	75421	10.0	340	25.9	80	T-40	25
SWW10.0X360	75422	10.0	360	25.9	80	T-40	25
SWW10.0X380	75423	10.0	380	25.9	80	T-40	25
SWW10.0X400	75424	10.0	400	25.9	80	T-40	25

For additional technical data, such as load-bearing capacities, installation data and more, visit our website [www.strongtie.co.uk](http://www.strongtie.co.uk).

# Structural Wood Screws

## Solid-Drive™ SWC Structural Countersunk WOOD Screw



### Structural Timber to Timber Connections Including Glulam, CLT and General Interior Applications

SWC is a countersunk structural screw designed for load-bearing wood structures. The SWC screw has a milling thread to allow for smooth driving of the shank. The countersunk head gives flush fitting while allowing the wood members to close up firmly.

These partially-threaded, 6.0, 8.0 and 10.0 mm diameter structural fasteners are designed to pull structural members together with superb holding power and excellent load capacity. The countersunk head and underhead nibs provide for clean countersinking, flush with the surface. Pre-drilling is not typically required. For interior and dry applications only.

**Features:**

- ETA approved (ETA-21/0670)
- UKTA approved (UKTA-22/6514)
- Countersunk head with underhead nibs creates a flush finish
- Type 17 cut point reduces the risk of wood splitting during the installation
- Heavy-duty thread and shank provides strength and stability
- Milling thread reduces the installation torque
- Deep 6-lobe recess provides improved control and greater bit life
- Head stamp includes length in mm for inspection

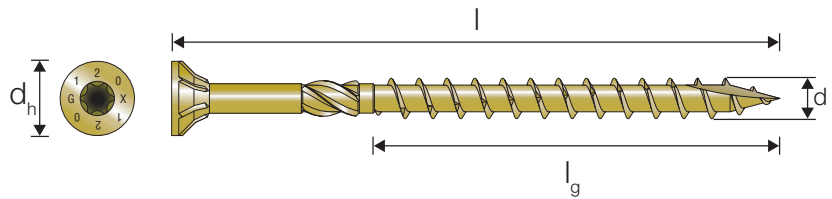

### SWC Yellow Zinc Plated

References	Item code	Dimensions [mm]				Bit	Box
		d	l	d <sub>h</sub>	l <sub>g</sub>		
SWC6.0X200	75346	6.0	200	11.8	70	T-30	100
SWC6.0X220	75347	6.0	220	11.8	70	T-30	100
SWC6.0X240	75348	6.0	240	11.8	70	T-30	100
SWC6.0X260	75349	6.0	260	11.8	70	T-30	100
SWC6.0X280	75350	6.0	280	11.8	70	T-30	100
SWC6.0X300	75351	6.0	300	11.8	70	T-30	100
SWC8.0X80	75352	8.0	80	14.6	50	T-40	50
SWC8.0X100	75353	8.0	100	14.6	50	T-40	50
SWC8.0X120	75354	8.0	120	14.6	80	T-40	50
SWC8.0X140	75355	8.0	140	14.6	80	T-40	50
SWC8.0X160	75356	8.0	160	14.6	80	T-40	50
SWC8.0X180	75357	8.0	180	14.6	80	T-40	50
SWC8.0X200	75358	8.0	200	14.6	80	T-40	50
SWC8.0X220	75359	8.0	220	14.6	80	T-40	50
SWC8.0X240	75360	8.0	240	14.6	80	T-40	50
SWC8.0X260	75361	8.0	260	14.6	80	T-40	50
SWC8.0X280	75362	8.0	280	14.6	80	T-40	50
SWC8.0X300	75363	8.0	300	14.6	80	T-40	50
SWC8.0X320	75364	8.0	320	14.6	80	T-40	50
SWC8.0X340	75365	8.0	340	14.6	80	T-40	50
SWC8.0X360	75366	8.0	360	14.6	80	T-40	50
SWC8.0X380	75367	8.0	380	14.6	80	T-40	50
SWC8.0X400	75368	8.0	400	14.6	80	T-40	50

# Structural Wood Screws

## SWC Yellow Zinc Plated

References	Item code	Dimensions [mm]				Bit	
		d	l	d <sub>h</sub>	l <sub>g</sub>		
SWC10.0X100	76916	10.0	100	17.8	80	T-40	25
SWC10.0X120	76917	10.0	120	17.8	80	T-40	25
SWC10.0X140	76918	10.0	140	17.8	80	T-40	25
SWC10.0X160	75369	10.0	160	17.8	80	T-40	25
SWC10.0X180	75370	10.0	180	17.8	80	T-40	25
SWC10.0X200	75371	10.0	200	17.8	80	T-40	25
SWC10.0X220	75372	10.0	220	17.8	80	T-40	25
SWC10.0X240	75373	10.0	240	17.8	80	T-40	25
SWC10.0X260	75374	10.0	260	17.8	80	T-40	25
SWC10.0X280	75375	10.0	280	17.8	80	T-40	25
SWC10.0X300	75376	10.0	300	17.8	80	T-40	25
SWC10.0X320	75377	10.0	320	17.8	80	T-40	25
SWC10.0X340	75378	10.0	340	17.8	80	T-40	25
SWC10.0X360	75379	10.0	360	17.8	80	T-40	25
SWC10.0X380	75380	10.0	380	17.8	80	T-40	25
SWC10.0X400	75381	10.0	400	17.8	80	T-40	25

For additional technical data, such as load-bearing capacities, installation data and more, visit our website [www.strongtie.co.uk](http://www.strongtie.co.uk).

# Structural Wood Screws

## Solid-Drive™

# SWD Structural Double Threaded WOOD Screw



### Structural Timber to Timber Connections Including Glulam, CLT and General Interior Applications

The Solid-Drive® SWD is a double threaded structural screw designed to connect and pull together two wood members.

The small cylinder-head reduces the insertion torque and makes it possible to countersink the screws. The Protec+ coating is a wear resistant coating that can endure the friction of the installation and the exposure of high loads from the structural applications.

SWD screws are suitable for inclined and angled installations. Use the GSCREW screw guide to ensure that screws are installed with the correct angle into the timber.

#### Features:

- ETA approved (ETA-21/0670)
- UKTA approved (UKTA-22/6514)
- Small cylinder head sinks into the wood allowing for hidden assemblies
- The chisel point allows for skewed installations
- The differentiated thread pitch creates a clamping effect that pulls the wood members together
- Deep 6-lobe recess provides improved control and greater bit life

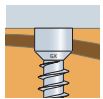

**Protec® +**

C3 acc. to EN ISO 12944-2  
SC2 - 50 years acc. to EC5

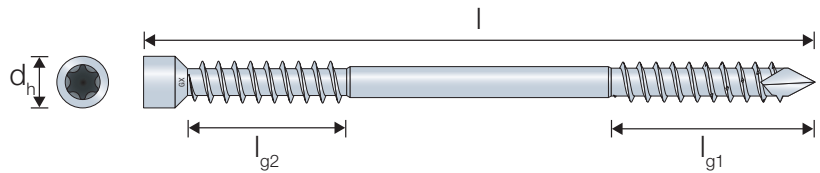

### SWD Protec®+ Coating

References	Item code	Dimensions [mm]					Bit	
		d	l	d <sub>n</sub>	l <sub>g1</sub>	l <sub>g2</sub>		
SWD6.5X65	75425	6.5	65	8	28	21.5	T-30	50
SWD6.5X90	75426	6.5	90	8	40	33.5	T-30	50
SWD6.5X130	75427	6.5	130	8	40	33.5	T-30	50
SWD6.5X160	75428	6.5	160	8	65	58.5	T-30	50
SWD6.5X190	75429	6.5	190	8	80	73.5	T-30	50
SWD6.5X220	75430	6.5	220	8	95	88.5	T-30	50
SWD8.0X90	75431	8.0	90	10	40	31.5	T-40	50
SWD8.0X130	75432	8.0	130	10	40	31.5	T-40	50
SWD8.0X160	75433	8.0	160	10	65	56.5	T-40	50
SWD8.0X190	75434	8.0	190	10	80	71.5	T-40	50
SWD8.0X220	75435	8.0	220	10	95	86.5	T-40	50
SWD8.0X245	75436	8.0	245	10	107.5	99	T-40	50
SWD8.0X275	75437	8.0	275	10	107.5	99	T-40	50
SWD8.0X300	75438	8.0	300	10	135	126.5	T-40	50
SWD8.0X330	75439	8.0	330	10	135	126.5	T-40	50

For additional technical data, such as load-bearing capacities, installation data and more, visit our website [www.strongtie.co.uk](http://www.strongtie.co.uk).

# Structural Wood Screws

## Solid-Drive™ ESCRFTC Structural Full Threaded Countersunk WOOD Screw



### Structural Timber to Timber Connections Including Glulam Seat Reinforcement and CLT Applications

The Solid-Drive® ESCRFTC wood screw is a structural fastener available in a variety of lengths and is designed for cross-laminated timber (CLT), glulam construction, beam reinforcement and general interior applications.

These full-threaded 8.0, 10.0 and 12.0 diameter [mm] structural fasteners are designed to pull structural members together with superb holding power and excellent load capacity. The half-cut point makes it easy to fix the screw in the correct angle and thereby ensure that inclined screws are installed with the correct angle. The countersunk head and underhead nibs provide for clean countersinking, flush with the surface. Pre-drilling is not typically required. For interior and dry applications only.

#### Features:

- ETA approved (ETA-13/0796)
- UKTA approved (UKTA-22/6524)
- Countersunk head with underhead nibs creates a flush finish
- Half-cut point gives low installation torque and no pre-drilling is required
- Heavy-duty thread and shank provides strength and stability
- Full threaded for excellent pull-out values and high load-bearing capacities
- Deep 6-lobe recess provides improved control and greater bit life
- Head stamp includes length in mm for inspection

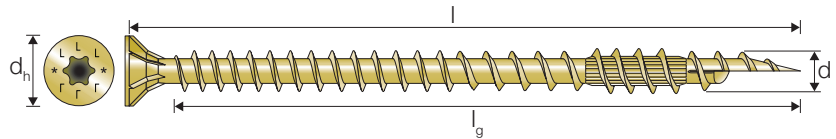

### ESCRFTC Yellow Zinc Plated

References	Dimensions [mm]				Bit	Box
	d	l	d <sub>h</sub>	l <sub>g</sub>		
ESCRFTC8.0X120	8.0	120	15.0	110	T-40	50
ESCRFTC8.0X140	8.0	140	15.0	130	T-40	50
ESCRFTC8.0X160	8.0	160	15.0	150	T-40	50
ESCRFTC8.0X180	8.0	180	15.0	170	T-40	50
ESCRFTC8.0X200	8.0	200	15.0	190	T-40	50
ESCRFTC8.0X220	8.0	220	15.0	210	T-40	50
ESCRFTC8.0X240	8.0	240	15.0	230	T-40	50
ESCRFTC8.0X260	8.0	260	15.0	250	T-40	50
ESCRFTC8.0X280	8.0	280	15.0	270	T-40	50
ESCRFTC8.0X300	8.0	300	15.0	290	T-40	50
ESCRFTC8.0X350	8.0	350	15.0	340	T-40	50
ESCRFTC8.0X400	8.0	400	15.0	390	T-40	50
ESCRFTC8.0X450	8.0	450	15.0	427	T-40	50
ESCRFTC10.0X120	10.0	120	18.5	108	T-50	50
ESCRFTC10.0X160	10.0	160	18.5	148	T-50	50
ESCRFTC10.0X180	10.0	180	18.5	168	T-50	50
ESCRFTC10.0X200	10.0	200	18.5	188	T-50	50
ESCRFTC10.0X220	10.0	220	18.5	208	T-50	50

References	Dimensions [mm]				Bit	Box
	d	l	d <sub>h</sub>	l <sub>g</sub>		
ESCRFTC10.0X240	10.0	240	18.5	228	T-50	50
ESCRFTC10.0X260	10.0	260	18.5	248	T-50	50
ESCRFTC10.0X280	10.0	280	18.5	268	T-50	50
ESCRFTC10.0X300	10.0	300	18.5	288	T-50	50
ESCRFTC10.0X350	10.0	350	18.5	338	T-50	50
ESCRFTC10.0X400	10.0	400	18.5	388	T-50	50
ESCRFTC10.0X450	10.0	450	18.5	426	T-50	50
ESCRFTC12.0X200	12.0	200	20.0	180	T-50	25
ESCRFTC12.0X220	12.0	220	20.0	200	T-50	25
ESCRFTC12.0X240	12.0	240	20.0	220	T-50	25
ESCRFTC12.0X260	12.0	260	20.0	240	T-50	25
ESCRFTC12.0X280	12.0	280	20.0	260	T-50	25
ESCRFTC12.0X300	12.0	300	20.0	280	T-50	25
ESCRFTC12.0X350	12.0	350	20.0	330	T-50	25
ESCRFTC12.0X400	12.0	400	20.0	380	T-50	25
ESCRFTC12.0X450	12.0	450	20.0	430	T-50	25
ESCRFTC12.0X500	12.0	500	20.0	480	T-50	25
ESCRFTC12.0X600	12.0	600	20.0	580	T-50	25

For additional technical data, such as load-bearing capacities, installation data and more, visit our website [www.strongtie.co.uk](http://www.strongtie.co.uk).

## Structural Wood Screws

**Solid-Drive™**ESCRFTZ/ESCRFT Structural Full Threaded Cylinder Head **WOOD** Screw*Structural Timber to Timber Connections Including Glulam, CLT and General Interior Applications*

The Solid-Drive® ESCRFTZ and ESCRFT wood screws are structural fasteners available in a variety of lengths and are designed for cross-laminated timber (CLT), glulam construction, beam reinforcement and general interior applications.

These full-threaded 8.0 and 10.0 diameter [mm] structural fasteners are designed to pull structural members together with superb holding power and excellent load capacity. The cylinder-head allows for deep countersinking and inclined installations. Pre-drilling is not typically required. For interior and dry applications only.

**Features:**

- ETA approved (ETA-13/0796)
- UKTA approved (UKTA-22/6524)
- Small cylinder head sinks into the wood allowing for hidden assemblies
- Full threaded for excellent pull-out values and high load-bearing capacities
- Heavy-duty thread and shank provides strength and stability
- Half-cut point which makes it easy to get a grip in the wood.

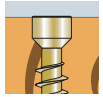
**Yellow Zinc Plated**

C2 acc. to EN ISO 12944-2  
SC2 - 50 years acc. to EC5

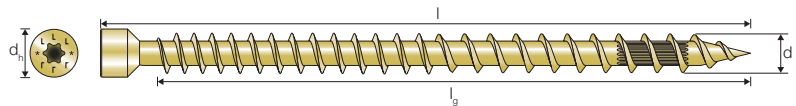

## ESCRFTZ Yellow Zinc Plated

References	Dimensions [mm]				Bit	
	d	l	d <sub>h</sub>	l <sub>g</sub>		
ESCRFTZ8.0X120	8.0	120	10.2	110	T-40	50
ESCRFTZ8.0X140	8.0	140	10.2	130	T-40	50
ESCRFTZ8.0X160	8.0	160	10.2	150	T-40	50
ESCRFTZ8.0X180	8.0	180	10.2	170	T-40	50
ESCRFTZ8.0X200	8.0	200	10.2	190	T-40	50
ESCRFTZ8.0X220	8.0	220	10.2	210	T-40	50
ESCRFTZ8.0X240	8.0	240	10.2	230	T-40	50
ESCRFTZ8.0X260	8.0	260	10.2	250	T-40	50
ESCRFTZ8.0X280	8.0	280	10.2	270	T-40	50
ESCRFTZ8.0X300	8.0	300	10.2	290	T-40	50
ESCRFTZ8.0X350	8.0	350	10.2	340	T-40	50
ESCRFTZ8.0X400	8.0	400	10.2	390	T-40	50

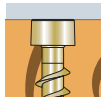
**Yellow Zinc Plated**

C2 acc. to EN ISO 12944-2  
SC2 - 50 years acc. to EC5

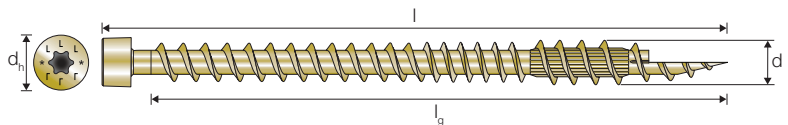

## ESCRFT Yellow Zinc Plated

References	Dimensions [mm]				Bit	
	d	l	d <sub>h</sub>	l <sub>g</sub>		
ESCRFT10.0X450	10.0	450	13.4	426	T-50	25
ESCRFT10.0X500	10.0	500	13.4	476	T-50	25
ESCRFT10.0X600	10.0	600	13.4	576	T-50	25
ESCRFT10.0X800	10.0	800	13.4	776	T-50	15
ESCRFT10.0X1000	10.0	1000	13.4	976	T-50	15

# Structural Wood Screws

## Solid-Drive™ SDW Structural WOOD Screw



### Structural Timber to Timber Connections and General Interior Applications

SDW is a structural wood screw available in a variety of lengths and is designed for cross-laminated timber assemblies, mass timber construction, log-home construction, ledgers and general interior applications.

These structural fasteners require less torque to install than comparable fasteners, and the large-diameter washer head pulls members down easily, eliminating the need to use extra washers.

#### Features:

- Low-profile head for reduced interference during handling or installation of hardware on the assembly
- High shear values enable wider screw spacing
- Bold thread design firmly clinches plies together to close gaps in multi-ply assemblies
- Optimal screw lengths provide maximum point side penetration
- Dimensions engraved on head for an easier identification even after installation

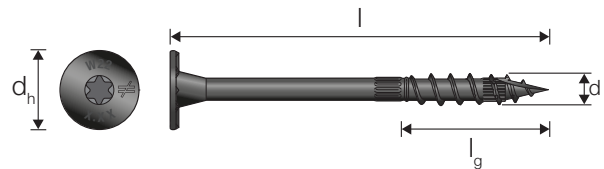
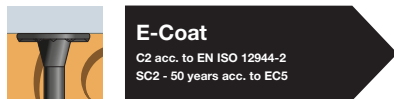

### SDW E-Coat

References	Dimensions [mm]				Bit	
	d	l	d <sub>h</sub>	l <sub>g</sub>		
SDW22258-R50E	8.0	66	19	36	T-40	50
SDW22300-R50E	8.0	76	19	37	T-40	50
SDW22338-R50E	8.0	86	19	40	T-40	50
SDW22438-R50E	8.0	111	19	37	T-40	50
SDW22458-R50E	8.0	117	19	37	T-40	50
SDW22500-R50E	8.0	127	19	40	T-40	50
SDW22600-R50E	8.0	152	19	37	T-40	50
SDW22638-R50E	8.0	162	19	37	T-40	50
SDW22634-R50E	8.0	172	19	40	T-40	50



# Structural Wood Screws

## Solid-Drive™ TTUFS/TTSFS Countersunk WOOD Screw



### Structural Timber to Timber Connections Including Glulam, CLT and General Timber Applications

The Solid-Drive® TTUFS and TTSFS countersunk wood screws are available in a variety of dimensions and are designed for general timber to timber applications as well as for cross-laminated timber (CLT) and glulam construction.

TTUFS screws are electro galvanised for standard interior and dry applications only. TTSFS screws are made in A4 stainless steel material and can therefore be used in applications where premium corrosion protection is required.

**Features:**

- ETA approved (ETA-21/0670)
- UKTA approved (UKTA-22/6514)
- Countersunk head sinks into the wood allowing for a flush finish
- Milling thread reduces the installation torque
- Type 17 cut point reduces the risk of wood splitting during the installation
- Deep 6-lobe recess provides improved control and greater bit life

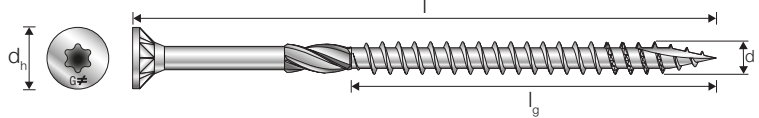
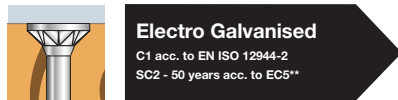
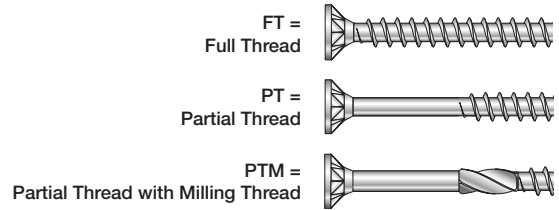

### TTUFS Electro Galvanised

















References	Item code	Dimensions [mm]				Thread	Bit	Box
		d	l	d <sub>h</sub>	l <sub>g</sub>			
TTUFS3.0X16*	74414	3.0	16	6.0	11	FT	T-10	200
TTUFS3.0X20*	74415	3.0	20	6.0	15	FT	T-10	200
TTUFS3.0X25*	74416	3.0	25	6.0	20	FT	T-10	200
TTUFS3.0X30*	74417	3.0	30	6.0	25	FT	T-10	200
TTUFS3.0X40*	77606	3.0	40	6.0	35	FT	T-10	200
TTUFS3.5X16*	74418	3.5	16	7.0	11	FT	T-15	200
TTUFS3.5X20*	74419	3.5	20	7.0	15	FT	T-15	200
TTUFS3.5X25*	74420	3.5	25	7.0	20	FT	T-15	200
TTUFS3.5X30*	74421	3.5	30	7.0	25	FT	T-15	200
TTUFS3.5X35*	74422	3.5	35	7.0	30	FT	T-15	200
TTUFS3.5X40*	74423	3.5	40	7.0	35	FT	T-15	200
TTUFS3.5X50*	74424	3.5	50	7.0	30	PT	T-15	200
TTUFS3.5X50*	77609	3.5	50	7.0	45	FT	T-15	200
TTUFS4.0X20*	74425	4.0	20	8.0	15	FT	T-20	200
TTUFS4.0X25*	74426	4.0	25	8.0	20	FT	T-20	200
TTUFS4.0X30*	77610	4.0	30	8.0	18	PT	T-20	200
TTUFS4.0X30*	74427	4.0	30	8.0	25	FT	T-20	200
TTUFS4.0X35*	74428	4.0	35	8.0	30	FT	T-20	200
TTUFS4.0X40*	77612	4.0	40	8.0	20	PT	T-20	200
TTUFS4.0X40*	74429	4.0	40	8.0	35	FT	T-20	200
TTUFS4.0X45*	74430	4.0	45	8.0	29	PT	T-20	200
TTUFS4.0X45*	77613	4.0	45	8.0	40	FT	T-20	200
TTUFS4.0X50*	74431	4.0	50	8.0	30	PT	T-20	200
TTUFS4.0X50*	77615	4.0	50	8.0	45	FT	T-20	200
TTUFS4.0X60*	74432	4.0	60	8.0	35	PT	T-20	200
TTUFS4.0X60*	77616	4.0	60	8.0	55	FT	T-20	200
TTUFS4.0X70*	74433	4.0	70	8.0	40	PT	T-20	200

\* Not included in ETA-21/0670

\*\*Screws with d ≤ 4.0 are SC1 - 50 years acc. to EC5

# Structural Wood Screws

## TTUFS Electro Galvanised

References	Item code	Dimensions [mm]				Thread	Bit	
		d	l	d <sub>h</sub>	l <sub>g</sub>			
TTUFS4.5X25	74434	4.5	25	8.4	20	FT	T-20	200
TTUFS4.5X30	74435	4.5	30	8.4	25	FT	T-20	200
 TTUFS4.5X35	77617	4.5	35	8.4	21	PT	T-20	200
TTUFS4.5X35	74436	4.5	35	8.4	30	FT	T-20	200
 TTUFS4.5X40	77618	4.5	40	8.4	20	PT	T-20	200
TTUFS4.5X40	74437	4.5	40	8.4	35	FT	T-20	200
TTUFS4.5X45	74438	4.5	45	8.4	29	PT	T-20	200
 TTUFS4.5X45	77619	4.5	45	8.4	40	FT	T-20	200
TTUFS4.5X50	74439	4.5	50	8.4	30	PT	T-20	200
 TTUFS4.5X50	77620	4.5	50	8.4	45	FT	T-20	200
TTUFS4.5X60	74440	4.5	60	8.4	35	PT	T-20	200
 TTUFS4.5X60	77627	4.5	60	8.4	55	FT	T-20	200
TTUFS4.5X70	74441	4.5	70	8.4	40	PT	T-20	100
TTUFS4.5X80	74442	4.5	80	8.4	50	PTM	T-20	100
 TTUFS5.0X30	74373	5.0	30	9.5	25	FT	T-25	200
 TTUFS5.0X35	77629	5.0	35	9.5	30	FT	T-25	200
 TTUFS5.0X40	77630	5.0	40	9.5	20	PT	T-25	200
TTUFS5.0X40	74374	5.0	40	9.5	35	FT	T-25	200
 TTUFS5.0X45	77631	5.0	45	9.5	40	FT	T-25	200
TTUFS5.0X50	74375	5.0	50	9.5	30	PT	T-25	200
 TTUFS5.0X50	77634	5.0	50	9.5	45	FT	T-25	200
TTUFS5.0X60	74376	5.0	60	9.5	35	PT	T-25	200
 TTUFS5.0X60	77635	5.0	60	9.5	55	FT	T-25	200
TTUFS5.0X70	74377	5.0	70	9.5	40	PT	T-25	100
TTUFS5.0X80	74378	5.0	80	9.5	40	PTM	T-25	100
TTUFS5.0X90	74379	5.0	90	9.5	45	PTM	T-25	100
TTUFS5.0X100	74443	5.0	100	9.5	60	PTM	T-25	100
 TTUFS5.0X120	74372	5.0	120	9.5	60	PTM	T-25	100
 TTUFS6.0X30	77636	6.0	30	11.6	24	FT	T-30	200
TTUFS6.0X40	74455	6.0	40	11.6	34	FT	T-30	200
TTUFS6.0X50	74457	6.0	50	11.6	30	PT	T-30	200
 TTUFS6.0X50	77637	6.0	50	11.6	44	FT	T-30	200
TTUFS6.0X60	74458	6.0	60	11.6	35	PT	T-30	200
 TTUFS6.0X60	77638	6.0	60	11.6	54	FT	T-30	200
TTUFS6.0X70	74459	6.0	70	11.6	40	PT	T-30	100
TTUFS6.0X80	74460	6.0	80	11.6	40	PTM	T-30	100
TTUFS6.0X90	74461	6.0	90	11.6	45	PTM	T-30	100
TTUFS6.0X100	74380	6.0	100	11.6	60	PTM	T-30	100
TTUFS6.0X120	74451	6.0	120	11.6	70	PTM	T-30	100
TTUFS6.0X140	74452	6.0	140	11.6	70	PTM	T-30	100
TTUFS6.0X160	74453	6.0	160	11.6	70	PTM	T-30	100
TTUFS6.0X180	74454	6.0	180	11.6	70	PTM	T-30	100

For additional technical data, such as load-bearing capacities, installation data and more, visit our website [www.strongtie.co.uk](http://www.strongtie.co.uk).

# Structural Wood Screws

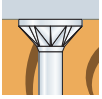

**Stainless Steel**

C5 acc. to EN ISO 12944-2  
SC3 - 50 years acc. to EC5

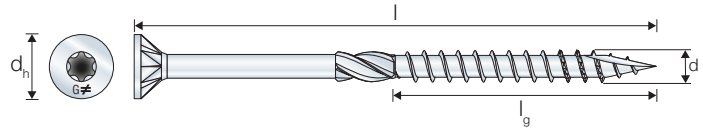

## TTSFS Stainless Steel A4

References	Item code	Dimensions [mm]				t <sub>fix</sub>	Thread	Bit	
		d	l	d <sub>h</sub>	l <sub>g</sub>				
TTSFS5.0X60	74446	5.0	60	9.5	32	28	PT	T-25	100
TTSFS5.0X70	74447	5.0	70	9.5	35	35	PT	T-25	100
TTSFS5.0X80	74448	5.0	80	9.5	40	40	PTM	T-25	100
TTSFS5.0X90	74449	5.0	90	9.5	45	45	PTM	T-25	100
TTSFS5.0X100	74444	5.0	100	9.5	55	45	PTM	T-25	100
TTSFS5.0X120	74445	5.0	120	9.5	60	60	PTM	T-25	100
TTSFS6.0X70	74473	6.0	70	11.6	35	35	PT	T-30	100
TTSFS6.0X80	74474	6.0	80	11.6	40	40	PTM	T-30	100
TTSFS6.0X90	74475	6.0	90	11.6	45	45	PTM	T-30	100
TTSFS6.0X100	74450	6.0	100	11.6	55	45	PTM	T-30	100
TTSFS6.0X120	74471	6.0	120	11.6	60	60	PTM	T-30	100
TTSFS6.0X140	74472	6.0	140	11.6	65	75	PTM	T-30	100

For additional technical data, such as load-bearing capacities, installation data and more, visit our website [www.strongtie.co.uk](http://www.strongtie.co.uk).

## Decking Screws

Deck-Drive™  
TTFA4 DECKING Screw, Stainless A4

## Decking boards to wood

Suitable for marine environments and industrial atmospheres. The TTFA4 screw will not discolour the woodwork around the screw head. Also suitable for precious woods such as oak, cedar or larch. The screw has a 6 lobe recess to ensure good grip and a cutpoint, which effectively drives the screw into the woodwork and counteracts splitting.

## Features:

- Countersunk with ribs
- Coarse thread
- Type 17 point

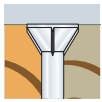

**Stainless Steel**  
C5 acc. to EN ISO 12944-2  
SC3 - 50 years acc. to EC5

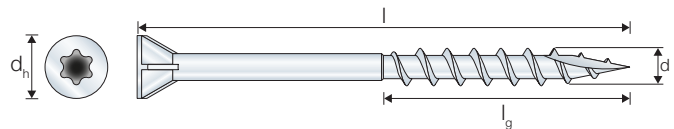

## TTFA4 Stainless Steel A4

References	Item code	Dimensions [mm]				Wood Thickness [mm]	Bit	
		d	l	d <sub>h</sub>	l <sub>g</sub>			
TTFA44.2X35	74385	4.2	35	7	20	< 14.0	T-20	250
TTFA44.2X45	74386	4.2	45	7	23	< 22.0	T-20	250
TTFA44.2X55	74387	4.2	55	7	27.5	< 27.5	T-20	250
TTFA44.2X55	74388	4.2	55	7	27.5	< 27.5	T-20	1400
TTFA44.8X75	74389	4.8	75	7	35	< 40.0	T-20	100

## TTFA4 Stainless Steel A4, Collated

References	Item code	Dimensions [mm]				Wood Thickness [mm]	Bit	
		d	l	d <sub>h</sub>	l <sub>g</sub>			
TTFA44.2X45	74291	4.2	45	7	23	< 22.0	PH2	1000
TTFA44.2X55	74292	4.2	55	7	27.5	< 27.5	PH2	1000
TTFA44.8X75	74293	4.8	75	7	35	< 40.0	PH2	400

\* Flat tape collated for standard auto-feed screwdrivers

For additional technical data, such as load-bearing capacities, installation data and more, visit our website [www.strongtie.co.uk](http://www.strongtie.co.uk).

## Decking Screws

Deck-Drive™  
DSIX4 DECKING Screw, Impreg® X4

## Decking boards to wood

The DSIX4 decking screws are designed for treated wood. The screws have a 6 lobe recess to ensure good grip. The type 17 point drives the screw efficiently and prevents wood splitting.

## Features:

- 6 lobe drive
- Countersunk with ribs
- Coarse thread
- Type 17 point

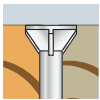

## Impreg® X4

C4 - 15 years acc. to EN  
ISO 12944-2  
SC2 - 50 years acc. to EC5

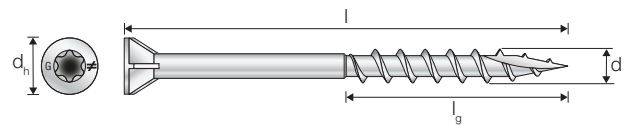

## DSIX4 Impreg® X4 Coating

References	Item code	Dimensions [mm]				Wood Thickness [mm]	Bit	
		d	l	d <sub>h</sub>	l <sub>g</sub>			
DSIX44.2X35T-20	74361	4.2	35	7	20	< 15.0	T-20	250
DSIX44.2X45T-20	74362	4.2	45	7	23	< 21.5	T-20	400
DSIX44.2X55T-20	74363	4.2	55	7	27	< 27.5	T-20	350
DSIX44.2X55T-20	74364	4.2	55	7	27	< 27.5	T-20	1400
DSIX44.2X75T-20	74365	4.2	75	7	41	< 34.5	T-20	300
DSIX44.2X75T-20	74366	4.2	75	7	41	< 34.5	T-20	750

## DSIX4 Impreg® X4 Coating, Collated\*

References	Item code	Dimensions [mm]				Wood Thickness [mm]	Bit	
		d	l	d <sub>h</sub>	l <sub>g</sub>			
DSIX44.2X55PH2	74294	4.2	45	7	23	< 21.5	PH2	1000
DSIX44.2X55PH2	74354	4.2	55	7	27	< 27.5	PH2	1000
DSIX44.2X75PH2	74355	4.2	75	7	41	< 34.5	PH2	400

\* Flat tape collated for standard auto-feed screwdrivers

For additional technical data, such as load-bearing capacities, installation data and more, visit our website [www.strongtie.co.uk](http://www.strongtie.co.uk).

## Decking / Facade Screws

# Deck-Drive™ DSPROA4 HARDWOOD DECKING Screw, Stainless



### Hardwood Decking Boards to Wood

The DSPRO hardwood decking screw is a powerful fastening solution for hardwood decking such as IPE, cumaro, bankirai and others. The screw can be used in Marine environments. The screw is designed to resist movement of the deck, a small head for a more professional finish and an additional thread to better pull the deck boards to the joist. Recommend pre-drilling with 4,0 mm drill and pre-countersinking close to the edge.



#### Features:

- 6 lobe drive
- Double threaded
- Chisel point

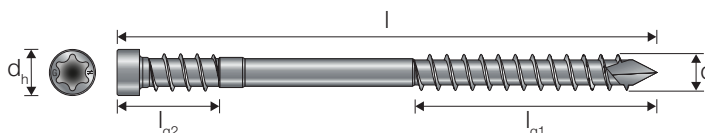

### DSPROA4 Stainless Steel

References	Item code	Dimensions [mm]					Wood Thickness [mm]	Bit	Box
		d	l	d <sub>h</sub>	l <sub>g1</sub>	l <sub>g2</sub>			
DSPROA45.5X50	74287	5.5	50	7.0	22.5	15.4	< 25.0	T-25	150
DSPROA45.5X60	74288	5.5	60	7.0	27.5	15.4	< 30.0	T-25	150
DSPROA45.5X70	74289	5.5	70	7.0	32.5	15.4	< 35.0	T-25	150
DSPROA45.5X80	74290	5.5	80	7.0	37.5	15.4	< 40.0	T-25	150

For additional technical data, such as load-bearing capacities, installation data and more, visit our website [www.strongtie.co.uk](http://www.strongtie.co.uk).

## CLSA4 Wood FACADE Screw

### Wood facades to wood

Made for outdoor wood cladding. The flat head with fiber lock technology protects the wood from moisture, and the double thread ensures sufficient insertion, even in high density wood without the risk of spin-off. Stainless A4 version made for non-painted facades or in marine environments.

#### Features:

- 6 lobe drive
- Flat head with fiber lock technology
- Double threaded
- Extreme ductility

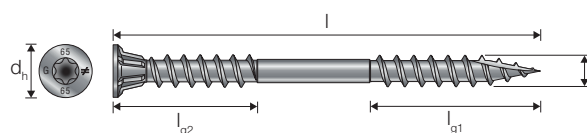
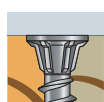

### CLSA4 Stainless Steel A4

References	Item code	Dimensions [mm]					Bit	Box
		d	l	d <sub>h</sub>	l <sub>g1</sub>	l <sub>g2</sub>		
CLSA44.8X48	75944	4.8	48	8	26	18	T-20	250
CLSA44.8X65	75945	4.8	65	8	26	22	T-20	250

# Assembly Screws

## SSP/FSM Steel to STEEL Screws

### Steel to Steel

Steel profile screws which are designed for joining reinforcement beams.

#### Features:

- Metal tapping thread



#### Phosphated

C1 acc. to EN ISO 12944-2  
SC1 - 50 years acc. to EC5

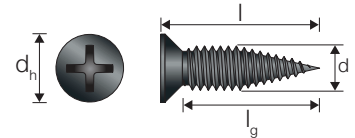

### SSP Phosphated

References	Item code	Dimensions [mm]				Steel Thickness [mm]	Bit	
		d	l	d <sub>h</sub>	l <sub>g</sub>			
SSP3.9X14	74399	3.9	14	6	Full thread	2 x 0.6	PH2	500



#### Phosphated

C1 acc. to EN ISO 12944-2  
SC2 - 50 years acc. to EC5

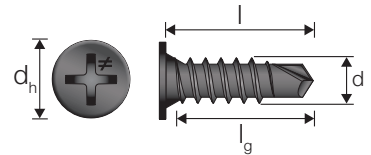

### FSM Phosphated

References	Item code	Dimensions [mm]				Steel Thickness [mm]	Bit	
		d	l	d <sub>h</sub>	l <sub>g</sub>			
FSM4.2X14	74398	4.2	14	8	Full thread	2 x 1.0	PH2	500



#### Electro Galvanised

C1 acc. to EN ISO 12944-2  
SC2 - 50 years acc. to EC5

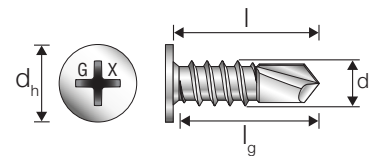

### FSM Electro Galvanised

References	Item code	Dimensions [mm]				Steel Thickness [mm]	Bit	
		d	l	d <sub>h</sub>	l <sub>g</sub>			
FSM4.8X16	74397	4.8	16	10	Full thread	2 x 2.0	PH2	500

# Assembly Screws

## HS/HSB Steel to STEEL Screws

### Steel to steel

Steel profile screws which are designed for joining reinforcement beams.

#### Features:

- Metal tapping thread
- Hexagonal head with PH drive

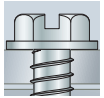

#### Electro Galvanised

C1 acc. to EN ISO 12944-2  
SC2 - 50 years acc. to EC5

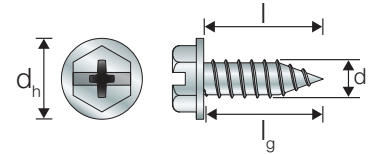

### HS Electro Galvanised

References	Item code	Dimensions [mm]				Steel Thickness [mm]	Bit	
		d	l	d <sub>h</sub>	l <sub>g</sub>			
HS4.2X13	74395	4.2	13	9	Full thread	< 1.0	1/4" + PH2	1000
HS4.2X19	74396	4.2	19	9	Full thread	< 1.0	1/4" + PH2	1000

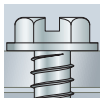

#### Electro Galvanised

C1 acc. to EN ISO 12944-2  
SC2 - 50 years acc. to EC5

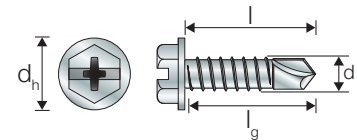

### HSB Electro Galvanised

References	Item code	Dimensions [mm]				Steel Thickness [mm]	Bit	
		d	l	d <sub>h</sub>	l <sub>g</sub>			
HSB4.2X13	74392	4.2	13	9	Full thread	< 2.25	1/4" + PH2	1000
HSB4.2X19	74393	4.2	19	9	Full thread	< 2.25	1/4" + PH2	1000
HSB4.2X25	74394	4.2	25	9	Full thread	< 2.25	1/4" + PH2	1000



## Board Screws

### FBCS FIBRE CEMENT Screw



#### Fibre cement to steel or wood

FBCS screws are used in humid conditions both indoor and outdoor. They are particularly suited for fixing fibre cement boards to wood or steel joists with a maximum thickness of 1.0 mm.

#### Features:

- PH drive
- Countersunk head with ribs
- Sharp point

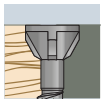

#### Impreg®+

C4 - 15 years acc. to EN  
ISO 12944-2  
SC2 - 50 years acc. to EC5

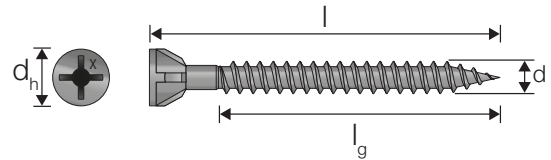

#### FBCS Impreg®+ Coating

References	Item code	Dimensions [mm]				Bit	
		d	l	d <sub>h</sub>	l <sub>g</sub>		
FBCS3.9X25	75453	3.9	25	6.8	18	PH2	250
FBCS3.9X35	75454	3.9	35	6.8	28	PH2	250

#### FBCS Impreg®+ Coating, Collated\*

References	Item code	Dimensions [mm]				Bit	
		d	l	d <sub>h</sub>	l <sub>g</sub>		
FBCS3.9X25	75719	3.9	25	6.8	18	PH2	1000
FBCS3.9X35	75720	3.9	35	6.8	28	PH2	1000

\* Flat tape collated for standard auto-feed screwdrivers  
Also available Quik Drive collated

For additional technical data, such as load-bearing capacities, installation data and more, visit our website [www.strongtie.co.uk](http://www.strongtie.co.uk).

## Board Screws

## FBCB FIBRE CEMENT Screw, Drill Point

*Fibre cement to steel*

FBCB screws are used in humid conditions both indoor and outdoor. They are particularly suited for fixing fibre cement boards to steel joists with a maximum thickness of 2.0 mm.

**Features:**

- PH drive
- Countersunk head with ribs
- Drill point

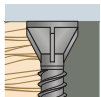
**Impreg®+**

C4 - 15 years acc. to EN ISO 12944-2  
SC2 - 50 years acc. to EC5

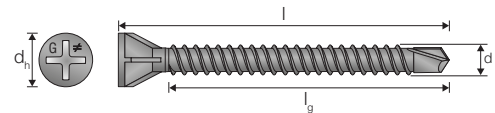

## FBCB Impreg®+ Coating

References	Item code	Dimensions [mm]				Bit	
		d	l	d <sub>h</sub>	l <sub>g</sub>		
FBCB3.9X25	75456	3.9	25	6.8	Full thread	PH2	250
FBCB3.9X35	75457	3.9	35	6.8	Full thread	PH2	250

## FBCB Impreg®+ Coating, Collated\*

References	Item code	Dimensions [mm]				Bit	
		d	l	d <sub>h</sub>	l <sub>g</sub>		
FBCB3.9X25	75721	3.9	25	6.8	Full thread	PH2	1000

\* Flat tape collated for standard auto-feed screwdrivers  
Also available Quik Drive collated

For additional technical data, such as load-bearing capacities, installation data and more, visit our website [www.strongtie.co.uk](http://www.strongtie.co.uk).

# Parts and Accessories

## Bits

References	Item code	Bit Type	l	
BITSPH2	75697	PH2	25	5
BITST10	75698	T-10	25	5
BITST15	75699	T-15	25	5
BITST20	75700	T-20	25	5
BITST25	75701	T-25	25	5
BITST30	75702	T-30	25	5
BITST40	75703	T-40	25	5
BITS#1	75695	Square #1	25	5
BITS#2	75696	Square #2	25	5
BIT2S-2-R2	BIT2S-2-R2	Square #2	50	2
BIT2SU-2-RC3	BIT2SU-2-RC3	Square #U2	50	3
BIT3S-2-R2	BIT3S-2-R2	Square #3	50	2
BIT3SU-2-RC3	BIT3SU-2-RC3	Square #U3	50	3

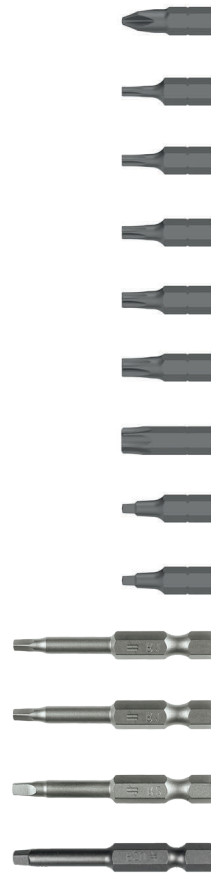

## Nutsetters

References	Item code	Bit Type	l	
BITSM8	75832	M8	Non-magnetic	1
BITSM8M	75833	M8	Magnetic	1

## Tools

References	Item code	Description	
DBWOODDSPRO	DBWOODDSPRO	Step-drill / pre-drilling tool	1
GSCREW	GSCREW4560-R	Installation guide (for right handed installers)	-
	GSCREW4560-L	Installation guide (for left handed installers)	-





**Nail the  
finishing touches.**

# Nails

## Connector Nails

CNA CONNECTOR Nail. . . . .	.62
N3.75 SQUARE TWIST Nail. . . . .	.63

## Wood Nails

ARA4 RING-SHANK WOOD Nail, Stainless A4 . . . . .	.64
---	-----

## Cladding Nails

CLNA4/CLNG WOOD-CLADDING Nail. . . . .	.65
--	-----

## Connector Nails

# Solid-Drive™ CNA CONNECTOR Nail



## Simpson Strong-Tie Connectors to Wood

The Solid-Drive CNA connector nail, which is supplied in many different lengths and sizes, loose and collated, is a fully documented ETA-approved fastener used for installing metal connectors to wood. Guaranteed load bearing capacities when using CNA nails to install Simpson Strong-Tie connectors.

CNA is available in a variety of different collations and is compatible with many pneumatic and gas-driven tools on the market. The collated nails are available as 34° plastic collated and 34° paper collated as well as 15° plastic coil collated.

### Features:

- ETA approved (ETA-04/0013)
- UKTA approved (UKTA-22/6512)
- Conical shape under the head for maximum fit in metal holes
- Length identification on head makes it easy to audit after installation
- Ring-shank increases the pull-out resistance
- Available in different types of collations

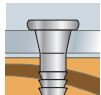

### Electro Galvanised

C1 acc. to EN ISO 12944-2  
SC2 - 50 years acc. to EC5

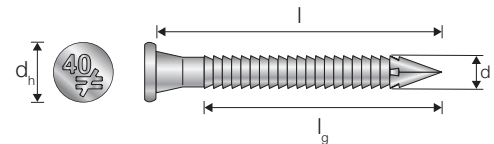

## CNA Electro Galvanised

References	Dimensions [mm]				
	d	l	d <sub>h</sub>	l <sub>g</sub>	
CNA3.1X40	3.1	40	6.2	30.0	500
CNA3.1X60	3.1	60	6.2	50.0	250
CNA3.7X50	3.7	50	7.4	40.0	250
CNA4.0X35*	4.0	35	7.0	26.0	250
CNA4.0X35-HV	4.0	35	7.0	26.0	1500
CNA4.0x40*	4.0	40	7.0	31.0	250
CNA4.0X40-FR	4.0	40	7.0	31.0	1500
CNA4.0X50*	4.0	50	7.0	41.0	250
CNA4.0X50-HV	4.0	50	7.0	41.0	1500
CNA4.0X60*	4.0	60	7.0	51.0	250
CNA4.0X60-HV	4.0	60	7.0	51.0	1000
CNA4.0X75	4.0	75	7.0	66.0	250
CNA4.0X75-HV	4.0	75	7.0	66.0	1000
CNA4.0X100	4.0	100	7.0	70.0	100
CNA6.0X60	6.0	60	12.0	50.0	100
CNA6.0X80	6.0	80	12.0	70.0	100
CNA6.0X100	6.0	100	12.0	70.0	100

\* Available as a collated nail for standard pneumatic tools. See more in the 'Collated Nails and Staples' section.



### Hot-Dip Galvanised

C4 acc. to EN ISO 12944-2  
SC3 - 50 years acc. to EC5

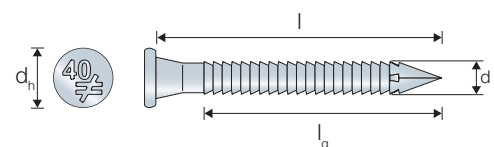

## CNA-G Hot-Dip Galvanised

References	Dimensions [mm]				
	d	l	d <sub>h</sub>	l <sub>g</sub>	
CNA4.0X40G*	4.0	40	7.0	30.0	250

# Connector Nails



**Stainless Steel**  
C5 acc. to EN ISO 12944-2  
SC3 - 50 years acc. to EC5

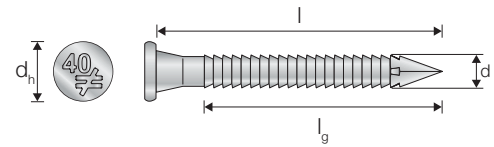

## CNA-S Stainless Steel A4

References	Dimensions [mm]				
	d	l	d <sub>h</sub>	l <sub>g</sub>	
CNA4.0X35S-HV	4.0	35	8.0	25.0	1500
CNA4.0X40S	4.0	40	8.0	30.0	250
CNA4.0X50S	4.0	50	8.0	40.0	250
CNA4.0X50S-HV	4.0	50	8.0	40.0	1500
CNA4.0X60S	4.0	60	8.0	50.0	250
CNA6.0X60S	6.0	60	12.0	50.0	100

For additional technical data, such as load-bearing capacities, installation data and more, visit our website [www.strongtie.co.uk](http://www.strongtie.co.uk).

## N3.75 SQUARE TWIST Nail



### Simpson Strong-Tie Connectors to Wood

N3.75 square twist nails are tested and approved for use when installing Simpson Strong-Tie connectors including joist hangers, brackets and straps. CE marked to EN14592.

#### Features:

- Square twist profile



**Sheradised**  
C1 acc. to EN ISO 12944-2  
SC2 - 50 years acc. to EC5

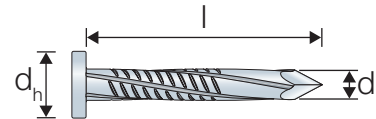

## N3.75-SH Sheradised

References	Dimensions [mm]			
	d	l	d <sub>h</sub>	
N3.75X30SH/1KG	3.75	30	8.0	370
N3.75X30SH/2.5KG	3.75	30	8.0	925
N3.75X30SH/5KG	3.75	30	8.0	1850
N3.75X30SH/25KG	3.75	30	8.0	9250

## Wood Nails

## ARA4 RING-SHANK WOOD Nail, Stainless A4



## Wood to Wood

This ring shank nail with its low oval head is used to fix wood components to wood, where high withdrawal strength is required. Grade A4 stainless steel can withstand severe outdoor environments.

## Features:

- Low oval head
- Ring shank



**Stainless Steel**  
C5 acc. to EN ISO 12944-2  
SC3 - 50 years acc. to EC5

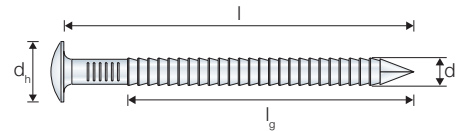

## ARA4 Stainless Steel A4

References	Item code	Dimensions [mm]				
		d	l	d <sub>h</sub>	l <sub>g</sub>	
ARA41.9X20*	74219	1.9	20	4.8	15	1000
ARA41.9X25*	74220	1.9	25	4.8	20	1000
ARA41.9X30*	74221	1.9	30	4.8	25	1000
ARA41.9X35*	74222	1.9	35	4.8	30	1000
ARA42.3X35	74223	2.3	35	5.5	27	1000
ARA42.3X45	74224	2.3	45	5.5	32	500
ARA42.3X50	74225	2.3	50	5.5	37	500
ARA42.3X50	75027	2.3	50	5.7	37	1800
ARA42.5X60	74226	2.5	60	5.7	42	250
ARA42.5X60	75028	2.5	60	6.1	42	1275
ARA43.1X75	74227	3.1	75	7.5	46	250

\* Not CE marked

For additional technical data, such as load-bearing capacities, installation data and more, visit our website [www.strongtie.co.uk](http://www.strongtie.co.uk).



# Cladding Nails

## CLNA4/CLNG WOOD-CLADDING Nail



### Cladding to Wood, Facade to Wood

The CLNA4 and CLNG nails are designed specifically to not penetrate the wind shield/protection behind the facade and with a flat head that covers the opened wood fibre after insertion. The ring shank increases the withdrawal performance and the 60 degree diamond point prevents splitting. The cladding nail in stainless steel can be used in severe environments, mainly used for unpainted facades or noble wood materials such as thermowood and cedar. The Hot-Dip Galvanised version is primarily for painted facades.

#### Features:

- Flat head
- 60 degree diamond point
- Ring shank



**Stainless Steel**  
C5 acc. to EN ISO 12944-2  
SC3 - 50 years acc. to EC5

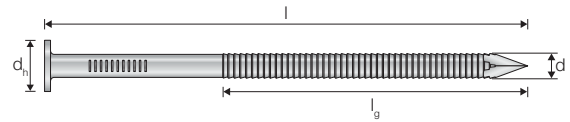

### CLNA4 Stainless Steel A4

References	Item code	Dimensions [mm]				
		d	l	d <sub>h</sub>	l <sub>g</sub>	
CLNA42.8X48	75650	2.8	48	6.9	26	500
CLNA42.8X65	75651	2.8	65	6.9	50	250
CLNA42.8x75	77033	2.8	75	6.9	53	250



**Hot-Dip Galvanised**  
C4 acc. to EN ISO 12944-2  
SC3 - 50 years acc. to EC5

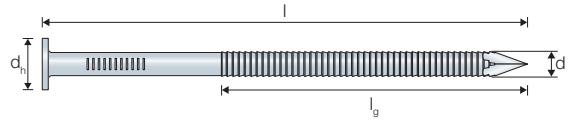

### CLNG Hot-Dip Galvanised

References	Item code	Dimensions [mm]				
		d	l	d <sub>h</sub>	l <sub>g</sub>	
CLNG2.8X48	75648	2.8	48	6.9	26	1000
CLNG2.8X65	75649	2.8	65	6.9	50	500

For additional technical data, such as load-bearing capacities, installation data and more, visit our website [www.strongtie.co.uk](http://www.strongtie.co.uk).

A close-up, circular-cropped photograph of a power tool handle. The handle is primarily black with a blue grip section and an orange plastic housing. The grip has a textured, ribbed pattern. The tool is positioned diagonally across the frame. The background is a blurred wooden structure.

**Unconditional speed  
and performance.**



# Collated Nails



## **Collated Connector Nails**

34° CNA CONNECTOR Nail, Paper Strip .....68

## **Collated Wood Framing Nails**

34° RSN WOOD-FRAMING Nail, Paper Tape .....69

34° RSND WOOD-FRAMING Nail, Paper Tape. ....69

## Collated Connector Nails

**Solid-Drive™****34° CNA CONNECTOR Nail, Paper Strip****Simpson Strong-Tie Connectors to Wood**

The CNA nails are specifically designed for use in Simpson Strong-Tie® connectors. The geometry and tolerances are specified in order to achieve the published connector loads.

**Features:**

- ETA approved (ETA-04/0013)
- UKTA approved (UKTA-22/6512)
- Conical shape under head designed for connectors
- Length identification on head makes it easy to audit after installation
- Round Head
- Annular ring thread
- Diamond point

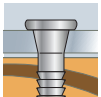

CNAPC34

**Electro Galvanised**

C1 acc. to EN ISO 12944-2  
SC2 - 50 years acc. to EC5

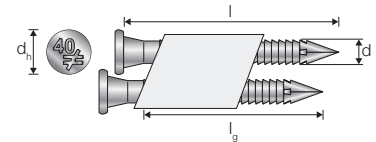
**CNAPC34 Electro Galvanised**

References	Dimensions [mm]				
	d	l	d <sub>n</sub>	l <sub>g</sub>	
CNA4.0X35PC34	4.0	35	7.0	26.0	1500
CNA4.0X40PC34	4.0	40	7.0	31.0	1500
CNA4.0X50PC34	4.0	50	7.0	41.0	1000
CNA4.0X60PC34	4.0	60	7.0	51.0	1000

For additional technical data, such as load-bearing capacities, installation data and more, visit our website [www.strongtie.co.uk](http://www.strongtie.co.uk).

# Collated Wood Framing Nails

## 34° RSN WOOD-FRAMING Nail, Paper Tape



### Framing Wood to Wood

The framing nail is used for wood to wood constructions. The round (off-set) head gives a good visual end result and the ring shank increases the withdrawal capacity.

**Features:**

- Off-set round head
- High withdrawal capacity
- Annular ring shank
- Paper tape 34°

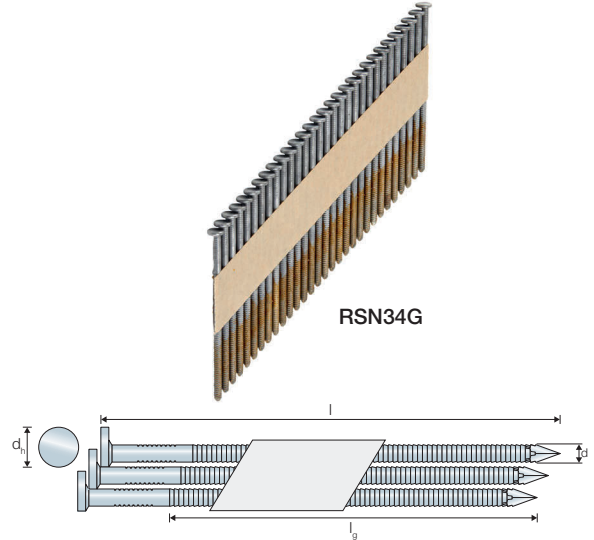

### RSN34G Hot-Dip Galvanised

References	Item code	Dimensions [mm]				📦
		d	l	d <sub>h</sub>	l <sub>g</sub>	
RSN34G2.8X65	75754	2.8	65	6.5	50	1700
RSN34G2.8X75	75755	2.8	75	6.5	60	1500
RSN34G3.1X90	75756	3.1	90	6.5	45	1000
RSN34G3.1X98	76150	3.1	98	6.5	35	1000

For additional technical data, such as load-bearing capacities, installation data and more, visit our website [www.strongtie.co.uk](http://www.strongtie.co.uk).

## 34° RSND WOOD-FRAMING Nail, Paper Tape



### Framing Wood to Wood

The framing nail is used for wood to wood constructions. The clipped head and the tight collation means that more nails can be loaded in the tools and the ring shank increases the withdrawal capacity.

**Features:**

- Clipped head (D-head)
- High withdrawal capacity
- Annular ring shank
- Paper tape 34°

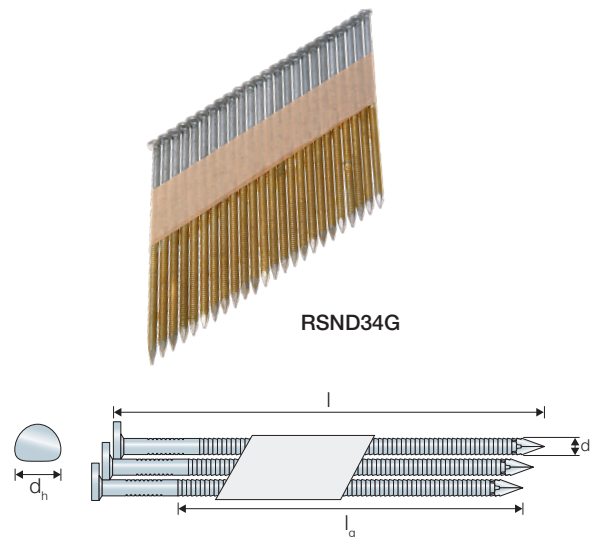

### RSND34G Hot-Dip Galvanised

References	Item code	Dimensions [mm]				📦
		d	l	d <sub>h</sub>	l <sub>g</sub>	
RSND34G2.8X65	75762	2.8	65	5.0	50	1700
RSND34G2.8X75	75763	2.8	75	5.0	60	1500
RSND34G3.1X90	75764	3.1	90	5.3	70	1000
RSND34G3.1X98	76149	3.1	98	5.3	35	1000

For additional technical data, such as load-bearing capacities, installation data and more, visit our website [www.strongtie.co.uk](http://www.strongtie.co.uk).



**Rethink  
repetitive fastening.**

# Quik Drive® Systems



## Quik Drive® Systems

Quik Drive® System Components . . . . .	73
Quik Drive® System Features . . . . .	73
QDBPC50E Connector Screw System . . . . .	75
QDBPC19EF 19 mm Flooring Screw System . . . . .	76
QDPRO76SKE Flooring and Decking System . . . . .	77
QDHSD Mezzanine Floor/Truck Bed System . . . . .	78
QDPRO51E Drywall Screw System . . . . .	80
QDPRO64E Flooring and Decking System . . . . .	81
QD76KE Multi-purpose System . . . . .	82
QDPRORFE Roofing Tile System . . . . .	83
QDPROLDHG2 Fibre Cement Board System . . . . .	84
QDPROPHG2 Light Gauge Steel Stud and Track System . . . . .	85
QDPROHX516G2 Metal Sheeting or Cladding System . . . . .	86
QDPROPP38KE Metal-Roofing Clips/Steel Decking/Stitching . . . . .	87

## Quik Drive® Bits

Driver Bits . . . . .	88
-----------------------	----

## Quik Drive® Adapters

Adapters for Corded Screwgun Motors . . . . .	89
Adapters for Cordless Screwgun Motors . . . . .	90
Adapter Installation Instructions . . . . .	90

## Quik Drive® Accessories

Accessories . . . . .	91
-----------------------	----

## General Information

Quik Drive® System Troubleshooting Guide . . . . .	93
--	----

# Quik Drive<sup>®</sup>

## A perfect alternative to traditional nailing and screwing.

The Quik Drive auto-feed system is a significantly faster way to install screws. With a multitude of modular fittings and screws for a huge range of purposes, there is a Quik Drive kit to suit just about every application - from drywall installation to mezzanine floor construction.

It's ergonomic too, allowing the installation of screws into walls, floors and ceilings without the need for bending, stretching or crouching. Which means not only can the system operate for several hours at a time - so can you.

Simple to use, the Quik Drive system fits onto most leading screwguns with just a click. The patented screw strips are designed to avoid jamming and unlike many collated screw strips, a partially used one can be saved for reuse later - so it's cost effective too.



- *Fast*
- *Reliable*
- *Ergonomic*

## Applications

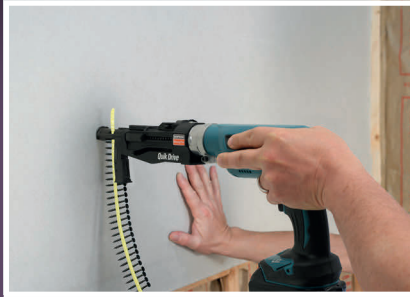
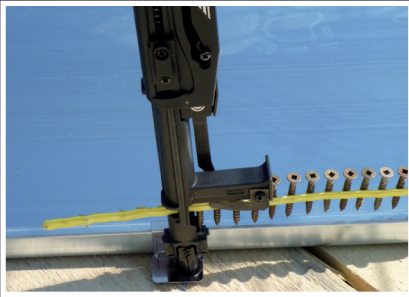



# Quik Drive® Systems

## Quik Drive® System Components



## Quik Drive® System Features

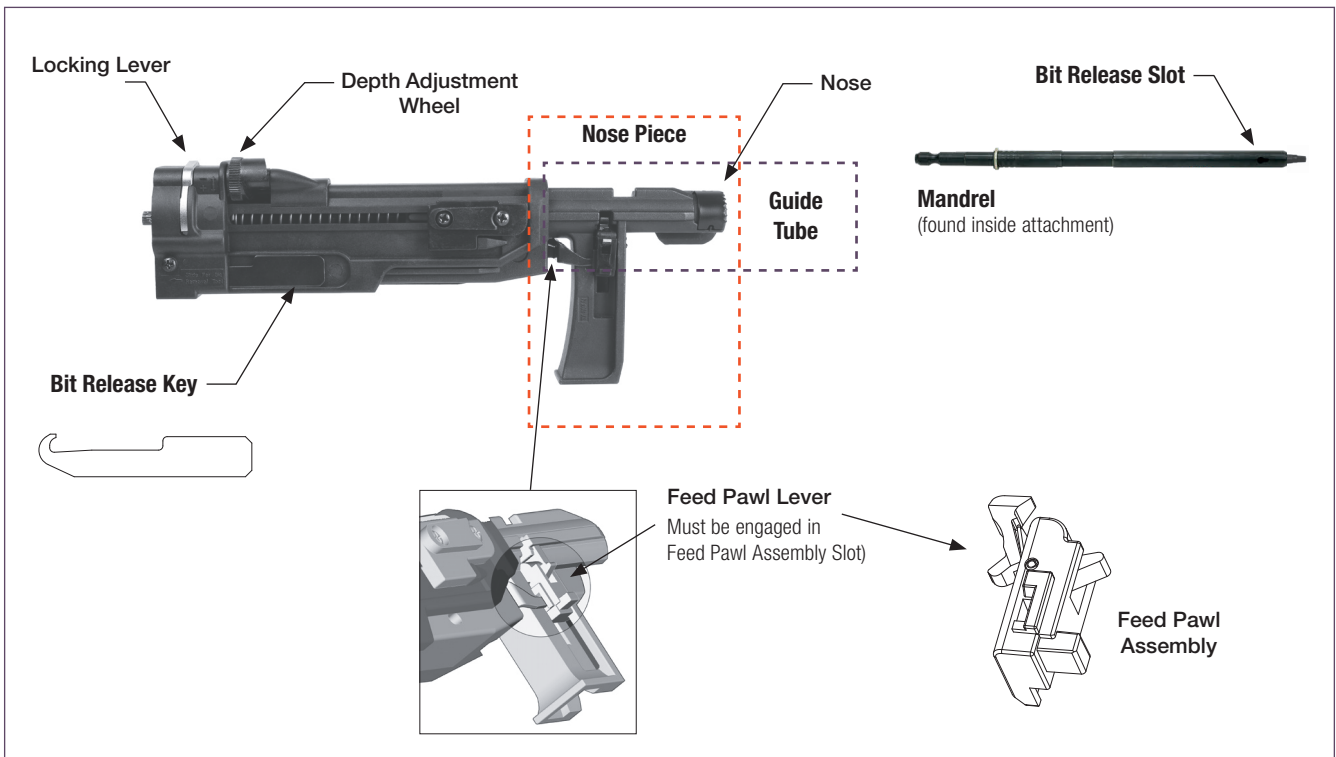

# Quik Drive® Systems

Find the attachment on page	Attachment	Systems		Application
75	QDBPC50E	QDBPC50E		Connector Screw System
76	QDBPC19EF	QDBPC19EF		19 mm Flooring Screw System
77	QDPRO76SKE	QDPRO76SKE		Flooring and Decking Screw System
		QDPRO76SKEG		
78	QDHSD60E	QDHSD60E		Mezzanine and Truck Bed Screw System
		QDHSD60KE		
78	QDHSD75E	QDHSD75E		Mezzanine and Truck Bed Screw System
80	QDPRO51E	QDPRO51E		Drywall Screw System
		QDPRO51KE		
		QDPRO51KEG		
81	QDPRO64E	QDPRO64E		Flooring and Decking Screw System
		QDPRO64KE		
82	QD76KE	QD76KE		Multipurpose System
83	QDPRORFE	QDPRORFE		Roofing Tile Screw System
84	QDPROLDHG2	QDPROLDHG2		Fibre Cement Board Screw System
85	QDPROPHG2	QDPROPHG2		Light Gauge Steel Stud and Track Screw System
86	QDPROHX516G2	QDPROHX516G2		Metal Sheeting and Cladding Screw System
87	QDPROPP38KE	QDPROPP38KE		Metal-Roofing Clips/Steel Decking/Stitching System

C-F-UK-2024 ©2024 SIMPSON STRONG-TIE COMPANY INC.

Quik Drive® Systems

# Quik Drive® Systems

## QDBPC50E CONNECTOR Screw System



- Suitable for screws 35 mm to 50 mm long
- Use with CSA screws to install metal connectors, such as angle brackets and joist hangers, to timber
- Use with Mandrel code: MANDREL128E
- Connects easily with screw gun or extension
- Made from rugged, self-lubricating material producing a long life and smooth operation
- Complete system incl. screw gun available



C-F-UK-2024 ©2024 SIMPSON STRONG-TIE COMPANY INC.

Kit includes:		QDBPC50E	Compatible Screws
Attachment	QDBPC50E	✓	CSA-T CSA-ST
Mandrel	MANDREL128E	✓	
Spare Bits	BITLTX20E (x1)	✓	



Quik Drive® Systems

# Quik Drive® Systems

## QDBPC19EF 19 mm **FLOORING** Screw System



- Suitable for MTHZ19E screws only
- Primarily used for over-plying (6mm ply)
- Use with Mandrel code: MANDREL128E-RC
- Connects easily with screw gun or extension
- Made from rugged, self-lubricating material producing a long life and smooth operation

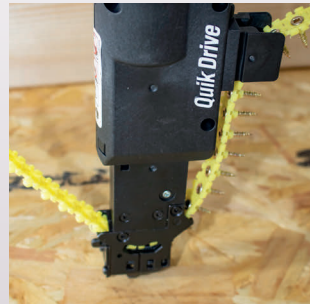

Quik Drive® Systems

Kit includes:		QDBPC19EF	QDBPC19EFKEGFS23	Compatible Screws
Attachment	QDBPC19EF	✓	✓	
Mandrel	MANDREL128E-RC	✓	✓	
Spare Bits	BITL2SE (x1)	✓	✓	
Carry Case	TOOLCASE-SML	✓	✓	
Strip Hook	HOOK	✓	✓	
Carry Case	TOOLCASE-LGE		✓	
Adapter	AMA9E-RC		✓	
Driver	MAKITA FS2300		✓	
Extension	QDEXTE		✓	



# Quik Drive® Systems

## QDPRO76SKE FLOORING and DECKING System



- Suitable for screws 44 mm to 76 mm long
- Used for fixing hardwood or softwood deck boards to timber sub frames. Also used in subfloor installation
- Use with Mandrel code: MANDREL191E-RC
- Self-locking depth adjustment for consistent countersink of screws
- Connects easily with screw gun or extension
- Made from rugged, self-lubricating material producing a long life and smooth operation

C-F-UK-2024 ©2024 SIMPSON STRONG-TIE COMPANY INC.

Kit includes:		QDPRO76SKE	Compatible Screws
Extension	QDEXTE	✓	CBSDQ CHB DTHQ SS3DSC SSDHPD SSDHSD SSDTH SSWSCB WSV
Attachment	QDPRO76SE	✓	
Pouch	QUIVER	✓	
Mandrel	MANDREL191E-RC	✓	
Carry Case	TOOLCASE-LG	✓	
Spare Bits	BIT2PE (x3)	✓	
	BIT2SE (x1)	✓	
	BIT3SUE (x1)	✓	

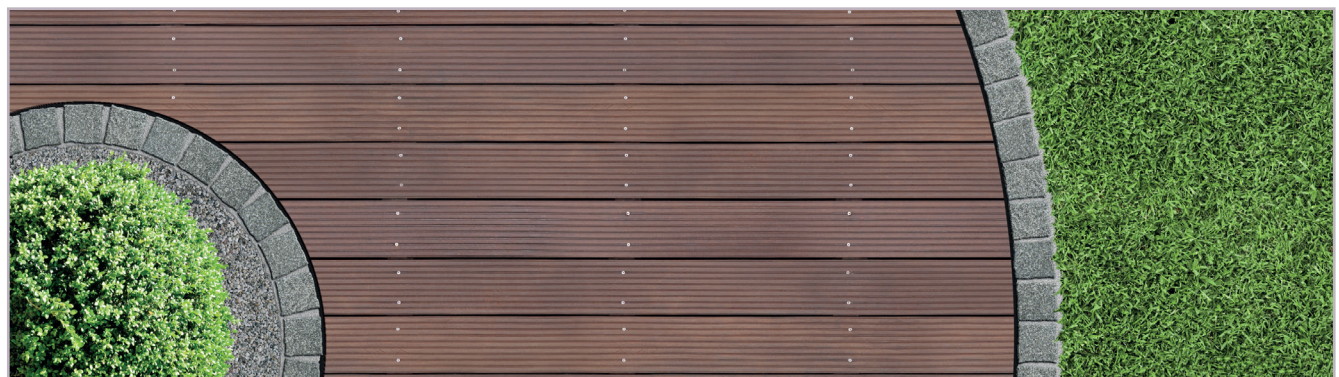

# Quik Drive® Systems

## QDHSD MEZZANINE Floor/TRUCK BED System



Use in conjunction with FHSD screws to drill through steel thicknesses 2-4 mm for mezzanine floor installations or the TBG screws to drill through 2-5 mm steel thicknesses for truck bed/trailer installations.

- QDHSD60E suitable for screws 45 mm to 64 mm
- QDHSD75E suitable for screws 60 mm to 75 mm
- Use with Mandrel code: MANDREL191E-RC
- Self-locking depth adjustment for consistent countersink of screws
- Connects easily with screw gun or extension
- Teflon coated moving parts for a long life
- Can be used in conjunction with the QDEXTG2-T2 handle
- Available as kits incl. extension, screw guns and more

Kit includes:		QDHSD60E	QDHSD75E	QDHSD60KE	Compatible Screws
Extension	QDEXTE			✓	
Attachment	QDHSD60E	✓		✓	
Attachment	QDHSD75E		✓		
Pouch	QUIVER			✓	
Mandrel	MANDREL191E-RC	✓	✓	✓	
Carry Case	TOOLCASE-LG			✓	
Spare Bits	BIT2SE (x1)	✓	✓	✓	
	BIT3SE (x3)	✓	✓	✓	



# Quik Drive® Systems



**QDEXTG2-T2 Handle**  
Mezzanine Floor Installation  
(Power tool is not included)

Designed for industrial applications where Quik Drive is operated for several hours at a time, such as mezzanine floor installations.

The T-Handle design allows a screw gun to be mounted such that the operator places equal amounts of pressure through both arms, making it much more comfortable to use over long periods.

- Two piece system
- Rugged, yet light box steel tube design
- Compatible with Makita screw guns and Quik Drive attachments
- QDEXTG2-T3 handle available for use with Hilti ST1800 screwdriver motors

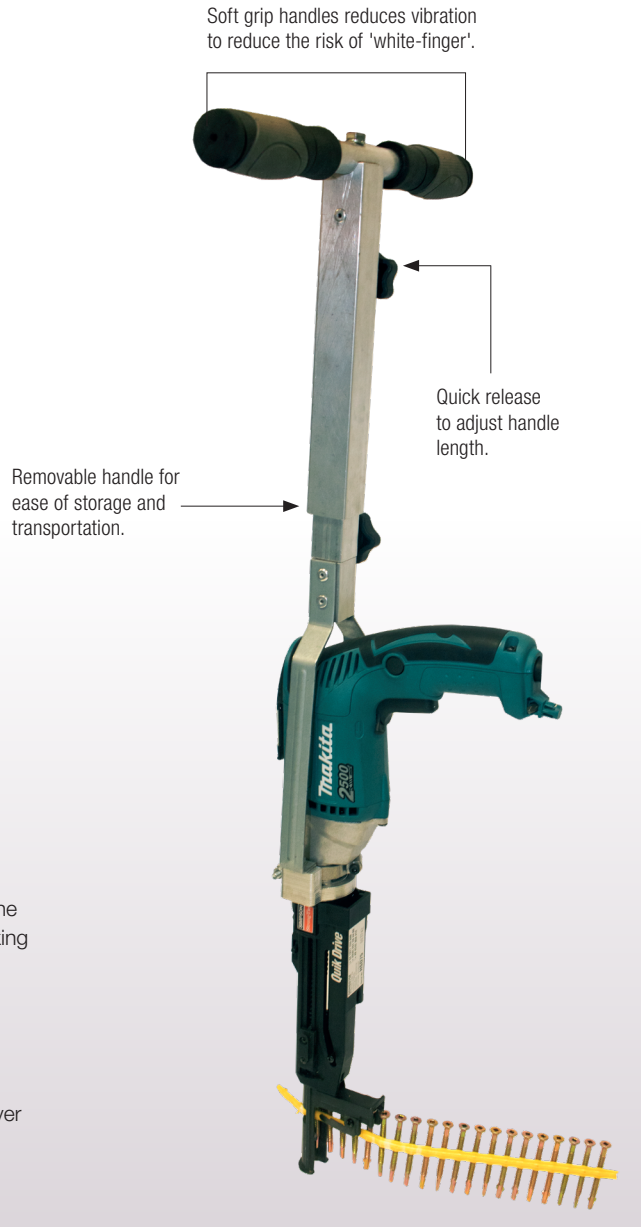

For additional technical information, such as installation data and more, visit our website [www.strongtie.co.uk](http://www.strongtie.co.uk).

# Quik Drive® Systems

## QDPRO51E DRYWALL Screw System



Smooth nose will not mark drywall surface.

Self-locking depth adjustment for consistent countersink.

- Suitable for screws 25 mm to 51 mm long
- Smooth nose piece prevents marking of drywall surface
- Use with Mandrel code: MANDREL165E-RC
- Self-locking depth adjustment for consistent countersinking of screws
- Connects easily with screw gun or extension
- Made from rugged, self-lubricating material producing a long life and smooth operation
- Available as kits incl. extension, screw guns and more

Kit includes:		QDPRO51E	QDPRO51KE	Compatible Screws	
Extension	QDEXTE		✓		
Attachment	QDPRO51E	✓	✓	CHB	MTH
Pouch	QUIVER	✓	✓	DWC	RDPF
Mandrel	MANDREL165E-RC	✓	✓	DWD	RDWF
Carry Case	TOOLCASE-LG		✓	DWF	RTFSD
Spare Bits	BIT2PE (x3)	✓	✓	DWFSD	WSC
	BIT2SE (x1)	✓	✓	DWHL	WSHL
	BIT3SUE	✓	✓	FBCB	
				FBCS	



C-F-UK-2024 ©2024 SIMPSON STRONG-TIE COMPANY INC.

### QDPRO51E



### QDPRO51KE





# Quik Drive® Systems

## QDPRO64E FLOORING and DECKING System

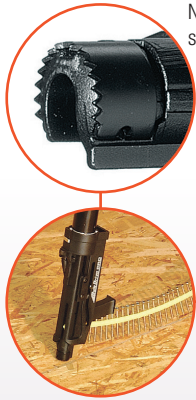

Non-skid nose piece increases stability (not interchangeable).



Uniform toe-nailing and countersink on slick surfaces.

- Suitable for screws 38 mm to 64 mm long
- Non-slip nose piece increases stability
- Use with Mandrel code: MANDREL191E-RC
- Self-locking depth adjustment for consistent countersink of screws
- Curved feeding guide for fast loading
- Replace-able non-skid teeth
- Connects easily with screw gun or extension
- Made from rugged, self-lubricating material producing a long life and smooth operation
- Available as kits incl. extension, screw guns and more

Kit includes:		QDPRO64E	QDPRO64KE	Compatible Screws	
Extension	QDEXTE		✓	CBSDQ CHB DTHQ	SSDTH SSWSCB WSV
Attachment	QDPRO64E	✓	✓		
Pouch	QUIVER		✓		
Mandrel	MANDREL191E-RC	✓	✓		
Carry Case	TOOLCASE-LG		✓		
Spare Bits	BIT2SE (x2)	✓	✓		
	BIT3SUE	✓	✓		



# Quik Drive® Systems

## QD76KE MULTI-PURPOSE System



NPA  
Nose Pieces



- Complete with interchangeable nose pieces, QD76KE can be used for a wide variety of applications including drywall, flooring and decking
- Suitable for screws 25 mm to 76 mm long
- Smooth nose piece prevents marking of drywall surface
- Use with Mandrel code: MANDREL191E-RC
- Self-locking depth adjustment for consistent countersink of screws
- Connects easily with screw gun or extension
- Made from rugged, self-lubricating material producing a long life and smooth operation
- Available as kits incl. extension, screw guns and more



Kit includes:		QD76KE	Compatible Screws
Extension	QDEXT	✓	DTHQ DWC DWF DWFSD DWHL MTH RTFSD SSDTH SSWSCB WSC WSHL
Attachment	QD76KE	✓	
Pouch	QUIVER	✓	
Mandrel	MANDREL191E-RC	✓	
Carry Case	TOOLCASE-LG	✓	
Spare Bits	BIT2PE (x2)	✓	
	BIT2SE (x1)	✓	
	BIT3SE (x1)	✓	
	BIT2SUE	✓	
	BIT3SUE (x1)	✓	
Nose Piece	51 mm - NPA2G2	✓	
	64 mm - NPA25G2	✓	
	76 mm - NPA3G2	✓	

- Interchangeable nose pieces included:
- 51 mm for 25 mm to 51 mm screws
- 64 mm for 38 mm to 64 mm screws
- 76 mm for 76 mm screws



# Quik Drive® Systems

## QDPRORFE ROOFING TILE System



Visibility window allows precise visual placement of screws

- Visibility window allows precise visual placement of screws
- Precision depth settings prevent tile breakage
- Made from rugged, self-lubricating material producing a long life and smooth operation



C-F-UK-2024 ©2024 SIMPSON STRONG-TIE COMPANY INC.

Kit includes:		QDPRORFE	Compatible Screws
Attachment	QDPRORFE	✓	CBSDQ DTHQ SS3DSC SSDHPD SSDTH SSWSCB WSC
Pouch	QUIVER	✓	
Mandrel	MANDREL191E-RC	✓	



For additional technical information, such as installation data and more, visit our website [www.strongtie.co.uk](http://www.strongtie.co.uk).

# Quik Drive® Systems

## QDPROLDHG2 FIBRE CEMENT BOARD System



Used in conjunction with CB3BLGHL screws to fix fibre cement boards to timber frame buildings. Also used with SSBFHSD screws for fixing to steel

- Suitable for screws 32 mm to 50 mm long
- Use with Mandrel code: MANDREL165E-RC
- Self-locking depth adjustment for consistent countersink of screws
- Connects easily with screw gun or extension
- Made from rugged, self-lubricating material producing a long life and smooth operation

Kit includes:		QDPROLDHG2	Compatible Screws
Attachment	QDPROLDHG2	✓	CB3BLGHL SSBFHSD
Mandrel	MANDREL165E-RC	✓	
Spare Bits	BIT2SUE (x1) / BIT3SUE (x1)	✓	



# Quik Drive® Systems

## QDPROPHG2 LIGHT GAUGE STEEL Stud and Track System



- Suitable for FPHSD and PHSD screws
- Use with Mandrel code: MANDREL165E-RC
- Self-locking depth adjustment for consistent countersink of screws
- Connects easily with screw gun or extension
- Made from rugged, self-lubricating material producing a long life and smooth operation

C-F-UK-2024 ©2024 SIMPSON STRONG-TIE COMPANY INC.

Kit includes:		QDPROPHG2	Compatible Screws
Attachment	QDPROPHG2	✓	FPHSD PHSD
Mandrel	MANDREL165E-RC	✓	
Spare Bits	BIT3SE (x3)	✓	

### QDPROPHG2



For additional technical information, such as installation data and more, visit our website [www.strongtie.co.uk](http://www.strongtie.co.uk).

Quik Drive® Systems

# Quik Drive® Systems

## QDPROHX516G2 METAL SHEETING or CLADDING System



Steel sheathing to steel system kit includes:

- Suitable for Hex Head screws up to 25 mm length
- Use with Mandrel code: BPHX516G2
- Self-locking depth adjustment for consistent positioning of screws
- Connects easily with screw gun or extension
- Made from rugged, self-lubricating material producing a long life and smooth operation

Kit includes:		QDPROHX516G2	Compatible Screws
Attachment	QDPROHX516G2	✓	X1S1214 X25E1016
Mandrel	BPHX516G2	✓	
Spare Bits	BITHEXLB516 (x1)	✓	



# Quik Drive® Systems

## QDPROPP38KE METAL-ROOFING Clips/ Steel Decking/Stitching



Innovative Precision Placement nosepiece allows for easy location of the hole in the clip

- Safely and efficiently performs steel deck fastening and stitching
- Auto-feed mechanism provides hands-free screw advancement, eliminating handling of individual screws, cutting installation time in half
- Collated fastener strips virtually eliminate fastener waste and prevent damage to roof panels from dropped fasteners
- Innovative Precision Placement™ nosepiece allows for easy location of the holes in standing seam metal roofing clips



C-F-UK-2024 ©2024 SIMPSON STRONG-TIE COMPANY INC.

Kit includes:		QDPROPP38KE	Compatible Screws
Extension	QDXTG2-16	✓	CB3BLGHL PCULP X1S1214 X25E
Attachment	QDPROPP38E	✓	
Pouch	QUIVER	✓	
Mandrel	MANDREL254E	✓	
Carry Case	TOOLCASE-LG	✓	
Spare Bits	BPHXLBPPG2	✓	



For additional technical information, such as installation data and more, visit our website [www.strongtie.co.uk](http://www.strongtie.co.uk).

# Quik Drive® Bits

## Driver Bits

		Item code	Description	Qty per pack
+		BIT2PE	<b>#2 Phillips bit</b>	
		BIT2PE-RC3	Bit pack #2 Phillips bit & wrench	3
		BIT2PE-RC10		10
		QRP2E-50		50
■		BIT2SE	<b>#2 Square Bit</b>	
		BIT2SE-RC3	Bit pack #2 square bit & wrench	3
		BIT2SE-RC10		10
		QRS2E-50		50
		BITL2SE	#2 Square Bit for QDBPC19EF	-
	BIT2S-2-R2 *	#2 Square Bit	2	
■		BIT2SUE	<b>#2U Undersized square bit</b>	
		BIT2SUE-RC3	Bit pack #2U Undersized square bit & wrench	3
		BIT2SUE-RC10		10
		QRSU2E-50		50
	BIT2SU-2-RC3 *	#2U Undersized square bit	3	
■		BIT3SE	<b>#3 Square bit</b>	
		BIT3SE-RC3	Bit pack #3 Square bit & wrench	3
		BIT3SE-RC10		10
		QRS3E-50		50
	BIT3S-2-R2 *	#3 Square Bit	2	
■		BIT3SUE	<b>#3 Undersized square bit</b>	
		BIT3SUE-RC3	Bit pack #3 Undersized square bit & wrench	3
		BIT3SUE-RC10		10
		QRSU3-50		50
	BIT3SU-2-RC3 *	#3 Undersized Square Bit	3	
⊙		BITHEXLB516 *	Hex bit 8 mm for QDPROHX516G2	1
*		BITLTX20E	<b>T-20 bit (for QDBPC50E)</b>	
		BITLTX20E-RC3	Bit pack T-20 long 6 lobe bit for QDBPC50E	3
		BITLTX20E-RC10		10
*		BITTX20	<b>T-20 bit</b>	
		BITTX20-RC3	T-20 bits	3
		BITTX20-RC10		10
*		BITTX25	<b>T-25 bit</b>	
		BITTX25-RC3	T-25 bits	3
		BITTX25-RC10		10

\* Bits not included with screws. Can be purchased separately.



Please ensure you use the correct bit. Most boxes of Quik Drive® screws contain a free bit on the underside of the lid.



# Quik Drive® Adapters

## Adapters for Corded Screwgun Motors

For detailed Quik Drive video user guides, visit [strongtie.co.uk/en-UK/solutions/quik-drive](http://strongtie.co.uk/en-UK/solutions/quik-drive)

### Driver with Cord

Screwgun	QD Adapter	Extension Compatible
Bosch®		
GSR 6-25	AB01E-RC	✓
GSR 6-45		
DeWalt®		
DW263K	ADWE-RC	✓
DW264K		
DW274K		
DW275K		
Eibenstock®		
ESR500	ASPITE-RC	✓
Hilti®		
SF4000	AHT2E-RC	Extension cannot be removed
SD2500		
SD5000		
SD6000		
ST1800	AHTE-RC	
ST2500		
Hitachi®		
W8VB	AHIE-RC	✓
W8VB2		
W6VB2		
W6VB3		
W6VA3		
W6VA4		
W6V3		
W6V4		
W6VM		
W4YD	Not possible	-

Screwgun	QD Adapter	Extension Compatible
Kress®		
500TBS	ASPITE-RC	✓
505TBS		
Makita®		
6822 - 6824	AMAE-RC	✓
6842 - 6844	AMA4E-RC	Extension cannot be removed
FS2300 / FS2500	AMA9E-RC	✓
FS4000 / FS4300		
FS6300		
Milwaukee®		
TKSE2500Q	AMIE-RC	-
DWSE4000Q4		
SPIT®		
214 / 216	ASPITE-RC	✓
217 / 218		
Würth®		
S50TB	ASPITE-RC	✓

\*1) Look at next page for correct mounting of adaptor

### Adapter Examples:



Bosch® is a trademark of Bosch Tool Corporation. Hilti® is a trademark of Hilti Corporation. Fine is a trademark of C. & E. FEIN GmbH. Hitachi® is a trademark of Hitachi Koki Co. LTD. Holzher® is a trademark of HOLZ-HER U.S. Inc. Kress is a trademark of KRESS-elektrik GmbH & Co. KG. Milwaukee® is a trademark of Milwaukee Electric Tool Corporation, Inc. DeWalt® is a trademark of DeWalt Industrial Tool, Co. Makita® is a Trademark of Makita Corporation. Spit® is a trademark of Illinois Tool Works Inc. Würth® is a trademark of Adolf Würth GmbH & Co. KG.

# Quik Drive® Adapters

## Adapters for Cordless Screwgun Motors

For detailed Quik Drive video user guides, visit [strongtie.co.uk/en-UK/solutions/quik-drive](http://strongtie.co.uk/en-UK/solutions/quik-drive)

### Cordless driver

Screwgun	QD Adapter	Extension Compatible
Bosch®		
GSR 10,8V-EC	AB01E-RC	✓
GSR 18V-EC TE		
DeWalt®		
DCF620N / DCF621N	DWA7G2	Modification of tool required to work with extension
DCF622	DWA3G2	Extension cannot be removed
Flex®		
ADW18-42	ASPITE-RC	✓
Hilti®		
SF4000A	AHT2E-RC	Extension cannot be removed
SD5000A	AHT2E-RC	
ST1800-A22	AHTE-RC	
Hitachi®		
WH18DL/DM	AH1E-RC	-
WF18DSL	Not possible	-
Kress®		
ATBS180	ASPITE-RC	✓

Screwgun	QD Adapter	Extension Compatible
Makita®		
BFS440 / BFS450	AMA8E-RC	Extension can not be removed
DFS450		
BFR550 / BFR750	AMA4E-RC	
DFR540 / 550 / 750		
BFS451	AMA9E-RC	✓
DFS250 / DFS251		
DFS451 / DFS452		
Metabo®		
SE18LTX2500	AHIE-RC	✓
SE18LTX4000		
SE18LTX6000		
Milwaukee®		
M18CIDM	MIA1G2	-
FSGC-202X	MIA2G2K	Extension cannot be removed
SPIT®		
216HDI	ASPITE-RC	✓
217LI / 218LI		
Würth®		
TBS18A	ASPITE-RC	✓

### Adaptor Installation Instructions

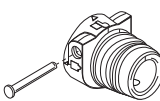
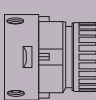
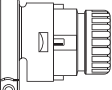
Adaptor types	Installation
Pin style 	<ol style="list-style-type: none"> <li>1. Unlock and remove the nose cone from the screw gun</li> <li>2. Remove the pin from the adaptor</li> <li>3. Place the adaptor on the screw gun</li> <li>4. Push the pin back in</li> </ol> <p>* This allows for an easy “No Tools Required” installation and removal of the QD adaptor.</p>
Set screw style 	<ol style="list-style-type: none"> <li>1. Unlock and remove the nose cone from the screw gun</li> <li>2. Remove factory bit</li> <li>3. Install QD adaptor</li> <li>4. Align flat located on screw gun and set screws located on QD adaptor</li> <li>5. Evenly tighten set screws with wrench provided</li> </ol>
Clamp style 	<ol style="list-style-type: none"> <li>1. Unlock and remove the nose cone from the screw gun</li> <li>2. Remove factory bit</li> <li>3. Install QD adaptor</li> <li>4. Tighten clamp with single screw to secure QD adaptor on screw gun</li> </ol>

# Quik Drive® Accessories

## Accessories

Description	Item code
Decking nose piece	DNPE
Decking nose Piece Alignment Aid for QD76KE	NPADCKAE-RC
Mandrel 128 mm (QDBPC50E)	MANDREL128E
Mandrel 128 mm (QDBPC50E)	MANDREL128E-RC
Mandrel 131 mm	MANDREL131E-RC
Mandrel 165 mm (QDPRO51 / QDPROPHG2)	MANDREL165E-RC
Mandrel 191 mm (QDPRO64 / QD76 / QDHSD)	MANDREL191E-RC
Mandrel 254 mm (QDPROPP38E)	MANDREL254E
Mandrel (QDPROHX516G2)	BPHX516G2
Nose Piece for QD76 Attachment: 51 mm	NPA2G2
Nose Piece for QD76 Attachment: 64 mm	NPA25G2
Nose Piece for QD76 Attachment: 76 mm	NPA3G2
Nose Piece for QDBPC50E Attachment	NPABPC50E
Feed Pawl for QDPROPH	PFEEDPAWL2E
Feed Pawl for QDHSD60E / QDHSD75E	PFEEDPAWL3E
Feed Pawl for QDPRO64 / QDPRO76SE	PFEEDPAWLE
Feed Pawl for QDPRO51 / QD76	PFEEDPAWLTLE
Nose Clip for QDPRO64E	PNOSECLIP
Deck Clip (QDPRO75SKE)	QDDECKCLIP-RC
Leaf Spring for QD Attachments	QDLEAFSPRING
Leaf Spring for QDPROHX516 Attachment	QDLEAFSPRING2
Spring for QDHSD60E / QDHSD75E	QDSPRING1E
Spring for QDPRO51E	QDSPRING2E
Spring for QDPROHX516G2	QDSPRING3E
Spring for QD76KE	QDSPRING4E
Quiver Pouch for Holding Screw Strips	QUIVER
Replacement attachment for QDPRO51E (excludes nose pieces)	SPA51E
Replacement attachment for QD76KE (excludes nose pieces)	SPA76E
Heavy Duty Case for kits	TOOLCASE-LG
Extension - 51 cm	QDEXTTE
Extension - 57 cm	QDEXTG3-22
T bar extension for Makita DFS251, FS2300 and FS2500	QDEXTG2-T2
T bar extension for Hilti ST1800	QDEXTG2-T3



PFEEDPAWL



QDDECKCLIP-RC



PNOSECLIP



QDPROHX516  
Leaf Spring



Leaf Spring



Spare Driver Bits  
3 pack



BITS  
10 pack



Spring



MANDREL



EXTENSION  
QDEXTTE



EXTENSION  
QDEXTG3-22



QUIVER



TOOLCASE-LG

## Quik Drive® Systems

### How to:

The Quik Drive® series of attachments are compatible with most leading power tools and can be installed with just a few steps, so you can be up and running in seconds.

#### Installation:

1. Pull off the depth stop cap of your drywall screwgun and remove all circlips
2. Pull out the bit holder of the screwgun
3. Mount the correct adapter onto the screwgun and tighten (you may require an allen key, supplied)
4. Insert the Quik Drive® bit holder (Mandrel) into the screwgun
5. Insert the attachment over the Mandrel and onto the adapter, clicking it into place
6. Insert the screw strip, with the pointed tip first, into the nose piece on the attachment
7. The Quik Drive® system is ready to use

Note: Always check the RPM of the driver matches the recommended speed for the screw you are installing.







# Quik Drive® Systems

## Quik Drive® Troubleshooting Guide

Symptom	Solution
Screws won't drive. They spin for a second, then lay over on their side.	Make sure the screw gun is not set to reverse. Make sure the screws are being driven straight.
Screws won't drive completely. They go down about halfway, then the bit spins out.	Check that you are using the correct bit for the type of screws you are using or if the bit is worn. Replace in either case. Keep constant pressure on when driving the screws.
Screws won't drive completely. They are almost completely driven but won't countersink fully.	Check the depth adjustment on the attachment and reset if necessary. You may have missed the substrate. For example in a flooring installation you may have missed the joist. Check that all cir-clips and rings have been removed from the front of the driver before the adapter is fitted.
Screws don't advance properly causing the the tool to jam.	Use only Simpson Strong-Tie® Quik Drive® screws. Make sure the screw strip is inserted correctly - pointed end first. Lift the tool completely off the work surface after driving each screw. Don't drag the screw strips on the work surface as you move. Be sure that the feed pawl assembly is intact and the feed lever engaged.

## Self-Drilling Screw Troubleshooting Guide

Failure Mode	Likely Cause(s)	Suggested Action
Split at point (web) 	Excessive force (feed) applied while drilling	Reduce application force
Outer corners worn or melted 	Drill RPM (cutting speed) too high	Use slower motor or partial trigger pull
Cutting edges chipping or breaking 	Excessive force (feed) applied while drilling	Reduce application force
Point melted or diameter significantly reduced 	<ul style="list-style-type: none"> <li>• Work material too hard</li> <li>• Insufficient chip clearance</li> <li>• Excessive force (feed) applied while drilling</li> </ul>	<ul style="list-style-type: none"> <li>• Confirm work material specs</li> <li>• Choose screw with longer pilot section</li> <li>• Reduce application force</li> </ul>
Screw spins without drilling a hole 	<ul style="list-style-type: none"> <li>• Drill motor set on reverse</li> <li>• Work material too hard</li> <li>• Drill point blunted by handling</li> </ul>	<ul style="list-style-type: none"> <li>• Check motor direction</li> <li>• Confirm work material specs</li> <li>• Inspect unused drill points for possible damage (from handling)</li> </ul>

Less torque.  
Less time.  
More fastening.





# Collated Screws for the Quik Drive® System



The patented curved collation strips hold the screws up and away from the work surface, making moving and positioning the tool easier. They are also pointed on the inserted end to simplify loading.

**Collated Drywall Screws**

DWC DRYWALL to Wood Screw . . . . .96

DWF DRYWALL to Steel Screw . . . . .97

DWHL DRYWALL to Wood and Steel Screw . . . . .98

DWFSD DRYWALL to Steel Screw . . . . .98

RDPF DIAMOND BOARD® to Wood and Steel Screw . . . . .99

RDWF DRYWALL to Wood and Steel Screw . . . . .99

RTFSD HARD-DRYWALL to Steel Screw . . . . .99

**Collated Underlayment and Board Screws**

MTH UNDERLAYMENT to Wood or Steel Screw . . . . .100

WSHL45E UNDERLAYMENT to Wood Screw . . . . .101

FHSD MEZZANINE FLOOR Screw . . . . .102

CBSDQ FIBRE CEMENT BOARD to Steel Screw . . . . .103

CB3BLGHL FIBRE CEMENT BOARD to Wood Screw . . . . .103

FBCS-E/FBCB-E FIBRE CEMENT Screw . . . . .104

**Collated Truck Bed Screw**

TBG TRUCK BED Screw, Outdoor . . . . .105

**Collated Standing Seam Screws**

PCULP STANDING-SEAM Roofing Screw . . . . .105

**Collated Connectors Screws**

CSA CONNECTOR Screw . . . . .106

**Collated Wood Flooring Screws**

WSV SUBFLOOR Screw . . . . .107

WSC WOOD FLOORING Screw, Coarse Thread . . . . .108

**Collated Wood Screws**

CHB WOOD FIBRE to Wood Screw . . . . .109

**Collated Cladding and Decking Screws**

CLSZN-E Wood FACADE Screw Screw . . . . .110

SSDTH Wood CLADDING and DECKING Screw . . . . .110

SS3DSC DECKING Screw . . . . .111

DTHQ Trim Head WOOD Screw . . . . .111

SSDHPD HARDWOOD-DECKING Screw . . . . .112

SSBFHSD Bi-Metal WOOD to METAL Screw . . . . .112

**Collated Roofing Tile Screws**

SSWSCB TILE ROOFING Screw, Coarse Thread . . . . .113

**Collated Steel Framing and Metal Screws**

PHSD STEEL FRAMING Screw, Pan Head . . . . .114

FPHSD STEEL FRAMING Screw, Flat Head . . . . .114

X SELF-DRILLING METAL Screw . . . . .114

# Quik Drive® Collated Drywall Screws

## DWC DRYWALL to Wood Screw



DWC is a bugle head screw with a sharp point tip suitable for drywall board to wood installation.

- Drywall board to wood applications
- Bugle head
- Sharp point with coarse thread
- Bit (BIT2PE) included



### Phosphated

C1 acc. to EN ISO 12944-2  
SC1 - 50 years acc. to EC5

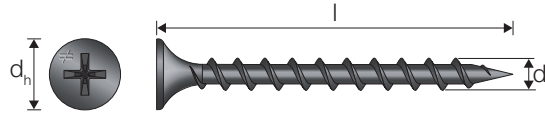

### DWC Phosphated

References	Dimensions [mm]			Qty per Strip	Qty per Pack	Recommended RPM	QDPR051E	QD76KE
	$d_h$	$d$	$l$					
DWC3935PE	8.2	3.9	35	30	2500	2500-6000	✓	✓
DWC3940PE	8.2	3.9	40	30	2500	2500-6000	✓	✓
DWC3945PE	8.2	3.9	45	30	2000	2500-4500	✓	✓
DWC3955PE	8.2	3.9	55	30	2000	2500-4500		✓
DWC3965PE	8.2	3.9	65	30	1500	2500-4500		✓



# Quik Drive® Collated Drywall Screws

## DWF DRYWALL to Steel Screw



DWF is a bugle head screw with a sharp point tip suitable for drywall board to light gauge steel installation.

- Drywall board to light gauge steel applications (0.6 to 0.9 mm thickness)
- Bugle head
- Sharp point with fine thread
- Bit (BIT2PE) included



**Phosphated**

C1 acc. to EN ISO 12944-2  
SC1 - 50 years acc. to EC5

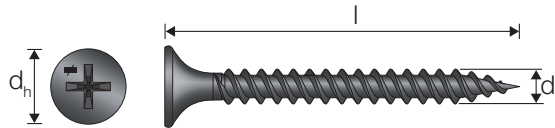

### DWF Phosphated

References	Dimensions [mm]			Qty per Strip	Qty per Pack	Recommended RPM	QDPRO51E	QD76KE
	d <sub>h</sub>	d	l					
DWF3525PE	8.2	3.5	25	30	2500	2500-6000	✓	✓
DWF3535PE	8.2	3.5	35	30	2500	2500-6000	✓	✓
DWF3540PE	8.2	3.5	40	30	2500	2500-6000	✓	✓

# Quik Drive® Collated Drywall Screws

## DWHL DRYWALL to Wood and Steel Screw



DWHL is a bugle head screw with a sharp point tip suitable for drywall board to wood or steel installation.

- Drywall board to light gauge steel applications (0.6 to 0.9 mm thickness)
- Bugle head
- Sharp point with high-low thread
- Bit (BIT2PE) included

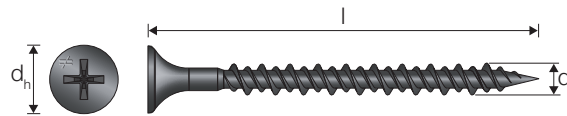
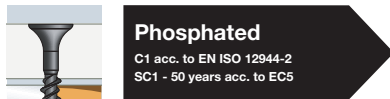

### DWHL Phosphated

References	Dimensions [mm]			Qty per Strip	Qty per Pack	Recommended RPM	QDPR051E	QD76KE
	d <sub>h</sub>	d	l					
DWHL48PE	8.2	3.8	48	30	2000	2500-6000	✓	✓

For additional technical data, such as load-bearing capacities, installation data and more, visit our website [www.strongtie.co.uk](http://www.strongtie.co.uk).

## DWFSD DRYWALL to Steel Screw



DWFSD is a self drilling screw with a fine thread, designed to fix drywall panels to steel of thicknesses 1.2 mm to 2.2 mm.

- Bugle head
- Drill point for improved penetration - even without pre-drilling
- Bit (BIT2PE) included

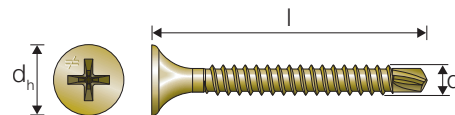

### DWFSD Yellow Zinc Plated

References	Dimensions [mm]			Qty per Strip	Qty per Pack	Recommended RPM	QDPR051E	QD76KE
	d <sub>h</sub>	d	l					
DWFSD32PE	8.2	3.4	32	30	2500	2500	✓	✓
DWFSD41PE	8.2	3.4	41	30	2500	2500	✓	✓

For additional technical data, such as load-bearing capacities, installation data and more, visit our website [www.strongtie.co.uk](http://www.strongtie.co.uk).

# Quik Drive® Collated Drywall Screws

## RDPF DIAMOND BOARD® to Wood and Steel Screw



RDPF is a fine threaded screw with a sharp point tip suitable for installing Diamond Board® to wood or steel.

- Sharp point
- Fine thread with reverse thread to aid countersinking of head
- Special for Diamond-board
- Bit (BIT2PE) included

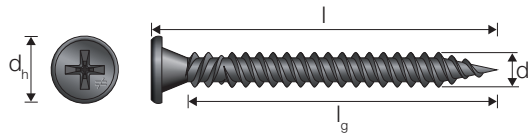
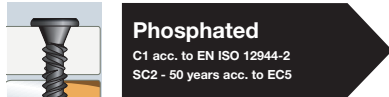

### RDPF Phosphated

References	Dimensions [mm]				Qty per Strip	Qty per Pack	Recommended RPM	QDPR051E	QD76KE
	d <sub>h</sub>	d	l	l <sub>g</sub>					
RDPF40PE	7.8	4.2	40	35.8	30	2500	2500-4000	✓	✓

For additional technical data, such as load-bearing capacities, installation data and more, visit our website [www.strongtie.co.uk](http://www.strongtie.co.uk).

## RDWF DRYWALL to Wood and Steel Screw



RDWF is a reduced bugle head screw suitable for installing drywall or hard drywall board to wood or steel.

- Reduced bugle head
- Sharp point
- High-low thread with reverse thread
- Bit (BIT2PE) included

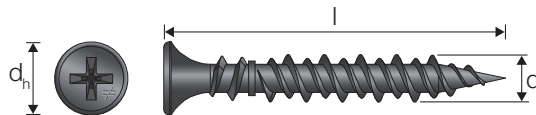
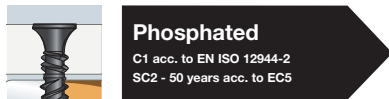

### RDWF Phosphated

References	Dimensions [mm]			Qty per Strip	Qty per Pack	Recommended RPM	QDPR051E	QD76KE
	d <sub>h</sub>	d	l					
RDWF30BE	6.3	4.2	30	30	2500	2500-4000	✓	✓
RDWF40BE	6.3	4.2	40	30	2500	2500-4000	✓	✓

For additional technical data, such as load-bearing capacities, installation data and more, visit our website [www.strongtie.co.uk](http://www.strongtie.co.uk).

## RTFSD HARD-DRYWALL to Steel Screw



Drywall screw with drill point for hard plasterboard on reinforced steel.

- Reduced bugle head
- Phosphated coating
- Steel thickness 1.0 mm to 2.0 mm
- Free bit (BIT2PE) included

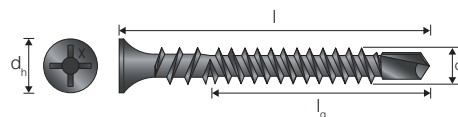
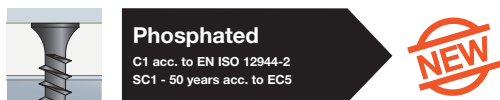

### RTFSD Phosphated

References	Dimensions [mm]			Qty per Strip	Qty per Pack	Recommended RPM	QDPR051	QD76KE
	d <sub>h</sub>	d	l					
RTFSD25E	6.2	3.9	25	30	2500	2500	✓	✓
RTFSD35E	6.2	3.9	38	30	2500	2500	✓	✓

For additional technical data, such as load-bearing capacities, installation data and more, visit our website [www.strongtie.co.uk](http://www.strongtie.co.uk).

# Collated Underlayment and Board Screws

## MTH UNDERLAYMENT to Wood or Steel Screw



The MTH underlayment screw is designed for fast and secure underlayment to subfloor installations. Unlike nails, the MTH underlayment screw has an intricate thread pattern designed to prevent squeaking by holding underlayment tight to the subfloor and thus preventing withdrawal. Its compact trim-head allows for a flush surface and prevents floor coverings from settling in countersink recesses.

MTH is a ribbed head screw with sharp point suitable for plywood or OSB to wood installations, such as flooring.

- Recommended for installing Fermacell board to steel up to 0.9mm thickness
- Deep recessed square drive holds bits tight, reducing cam-outs
- High-low thread for easy driving and holding underlayment tight
- Specially-designed sharp point for fast starts
- Trim-Head with nibs for easy countersinking
- Plywood or OSB to wood applications
- Bit (BIT2SE) included

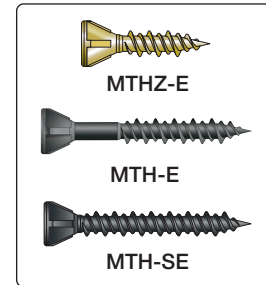

**Phosphated/Yellow Zinc**  
C1 acc. to EN ISO 12944-2  
SC1 - 50 years acc. to EC5

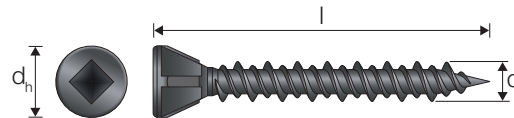

### MTHE / MTHSE / MTHZE

References	Dimensions [mm]			Qty per Strip	Qty per Pack	Recommended RPM	QDBPC19EF	QDPR051E	QD76KE
	d <sub>h</sub>	d	l						
<b>NEW</b> MTHZ19E **	6.9	3.8	19	50	1500	2500	✓		
MTHZ25E **	6.9	3.8	25	30	2500	2500-4000		✓	✓
MTH25E *	6.9	3.8	25	30	2500	2500-4000		✓	✓
MTH32E *	6.9	3.8	32	30	2500	2500-4000		✓	✓
MTH32SE *	6.9	3.8	32	30	2500	2500-4000		✓	✓

\* Grey phosphate finish

\*\* Yellow zinc plated

### Quik Drive® Performance Data

#### Application to Steel

Reference	Connection Detail	Performance Values					
		Pull out		Pull through		Shear	
		F <sub>k</sub> [kN]	Min. Pointside Penetration	F <sub>k</sub> [kN]	Min. Headside Material thickness	F <sub>k</sub> [kN]	Members
MTHZ25E	Fermacell to Steel	0.85	-	0.95	12.5	1.80	12.5 mm Fermacell to ≥ 0.7 mm Steel
MTH32E	Fermacell to Steel	0.85	-	0.95	12.5	1.80	12.5 mm Fermacell to ≥ 0.7 mm Steel

#### Application to Wood

MTHZ25E	Fermacell to Wood	0.60	13	0.95	12.5	0.70	12.5mm Fermacell to ≥ 12.5mm Wood
MTH32E	Fermacell to Wood	1.15	20	0.95	12.5	0.95	12.5mm Fermacell to ≥ 20mm Wood

- 1) All Wood C24 grade
- 2) All steel in strength class S275

For additional technical data, such as load-bearing capacities, installation data and more, visit our website [www.strongtie.co.uk](http://www.strongtie.co.uk).

# Collated Underlayment and Board Screws

## WSHL45E UNDERLAYMENT to Wood Screw



WSHL45E is designed for fast and secure fixing of fibreboard/Fermacell to wood/steel. Also suitable for fixing timber to timber such as flooring applications.

- Rimmed flat head with nibs for easy countersinking
- High-low thread
- Sharp point
- Bit (BIT2SE) included
- Subfloor to wood
- Fermacell board to steel



**Phosphated**

C1 acc. to EN ISO 12944-2  
SC1 - 50 years acc. to EC5

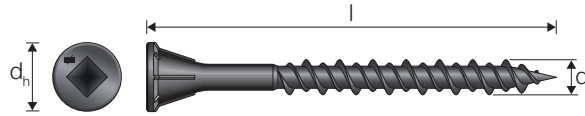

### WSHL45E Phosphated

References	Dimensions [mm]			Qty per Strip	Qty per Pack	Recommended RPM	QDPR051E	QD76KE
	d <sub>h</sub>	d	l					
WSHL45E	6.9	3.8	45	30	2000	2500-4000	✓	✓

For additional technical data, such as load-bearing capacities, installation data and more, visit our website [www.strongtie.co.uk](http://www.strongtie.co.uk).

# Collated Underlayment and Board Screws

## FHSD MEZZANINE FLOOR Screw

FHSD is a drill point screw suitable for wood to light gauge steel installations such as mezzanine floors.

- Wood to light gauge steel (2.0 to 4.0 mm thickness) applications
- Drill point to help clear hole and penetrate steel
- Bit (BIT2SE) included

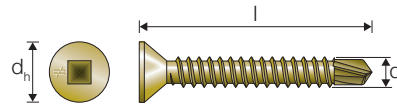

### FHSD Yellow Zinc Plated

References	Dimensions [mm]			Qty per Strip	Qty per Pack	Recommended RPM	QDPR051E	QD76KE
	d <sub>h</sub>	d	l					
FHSD32E0818	8.0	4.1	32	23	2500	1000-2500	✓	✓

FHSD is a ribbed head screw with a winged drill point suitable for wood to light gauge steel installations such as mezzanine floors.

- Wood to light gauge steel (2.0 to 4.0 mm thickness) applications
- Winged drill point to help clear hole and penetrate steel
- Bit (BIT3SE) included
- Countersunk head with ribs

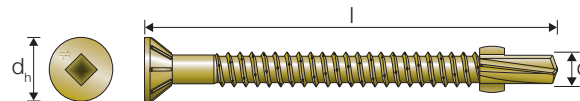

### FHSD Yellow Zinc Plated

References	Dimensions [mm]			Qty per Strip	Qty per Pack	Recommended RPM	QDHS060E	QDHS075E
	d <sub>h</sub>	d	l					
FHSD45E	9.9	5.5	45	23	750	1000-2500	✓	
FHSD64E	9.9	5.5	64	23	750	1000-2500	✓	✓

## Quik Drive® Performance Data

### Application to steel

Reference	Connection Detail	Performance Values				
		Pull out	Pull through		Shear	
		F <sub>k</sub> [kN]	F <sub>k</sub> [kN]	Min. Headside Material thickness	F <sub>k</sub> [kN]	Members
FHSD64E	Wood to Steel	7.20	1.35	15	1.65	18 mm Wood to 2 mm Steel

1) All Wood C24 grade  
2) All steel in strength class S275

## Collated Underlayment and Board Screws

### CBSDQ FIBRE CEMENT BOARD to Steel Screw



CBSDQ is a ribbed head screw with a drill point tip suitable for fibre cement board/wood to steel installations such as in modular housing construction. Also suitable for timber to steel applications.

- Ideally suited to modular housing construction
- Fibre cement board cladding to steel framing (1.0 to 3.0 mm thickness)
- Ribbed head
- Drill point with wings
- Bit (BIT2SUE) included



Quik Guard® Coating

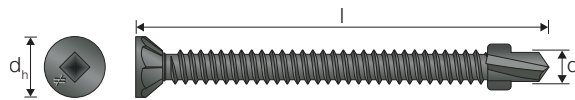

#### CBSDQ Quik Guard® Coating

References	Head Diameter (mm)	Thread Diameter (mm)	Length (mm)	Thread length (mm)	Qty per Strip	Qty per Pack	Recommended RPM	QDPR064E	QDPR076SKE
CBSDQ41E	8.4	4.2	41	30	30	1500	1700-2500	✓	✓
CBSDQ55E	8.4	4.8	57	45	30	1000	1700-2500	✓	✓

For additional technical data, such as load-bearing capacities, installation data and more, visit our website [www.strongtie.co.uk](http://www.strongtie.co.uk).

### CB3BLGHL FIBRE CEMENT BOARD to Wood Screw



CB3BLGHL is a ribbed head screw with a drill point tip suitable for fibre cement board to wood installations.

- Ribbed head
- Sharp point with high-low thread
- Cement board to wood applications
- Bit (BIT2SE) included



Mechanically Galvanised

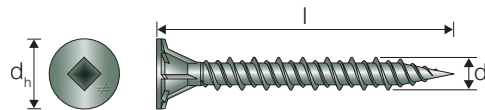

#### CB3BLGHL C3 Mechanically Galvanised Coating

References	Dimensions [mm]			Qty per Strip	Qty per Pack	Recommended RPM	QDPR0LDHG2
	d <sub>h</sub>	d	l				
CB3BLGHL32E	9.7	4.5	32	22	1500	4000	✓
CB3BLGHL41E	9.7	4.5	41	22	1500	4000	✓

For additional technical data, such as load-bearing capacities, installation data and more, visit our website [www.strongtie.co.uk](http://www.strongtie.co.uk).

## Quik Drive® Collated Screws

### FBCS-E FIBRE CEMENT Screw



Quik Drive collated FBCS screws are used in humid conditions both indoor and outdoor. They are particularly suited for fixing fibre cement boards to wood or steel joists with a maximum thickness of 1.0 mm.

- PH drive
- Countersunk head with ribs
- Sharp point
- Fibre cement to steel or wood

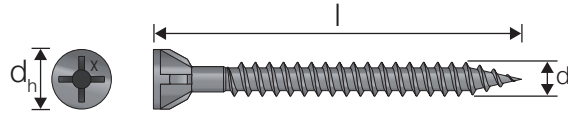
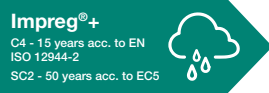
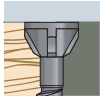

#### FBCS-E Impreg®+ Coating

References	Dimensions [mm]			Qty per Strip	Qty per Pack	Recommended RPM	QDPR051	QD76KE
	d <sub>h</sub>	d	l					
FBCS25E	6.8	3.9	25	30	2500	2500-4000	✓	✓
FBCS35E	6.8	3.9	35	30	2500	2500-4000	✓	✓
FBCS45E	6.8	3.9	45	30	2000	2500-4000	✓	✓

Each kit includes BIT2PE driver bit.

For additional technical data, such as load-bearing capacities, installation data and more, visit our website [www.strongtie.co.uk](http://www.strongtie.co.uk).

### FBCB-E FIBRE CEMENT Screw, Drillpoint



Quik Drive collated FBCB screws are used in humid conditions both indoor and outdoor. They are particularly suited for fixing fibre cement boards to steel joists with a maximum thickness of 2.0 mm.

- PH drive
- Countersunk head with ribs
- Drill point
- Fibre cement to steel

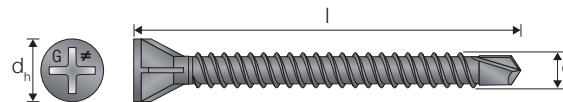
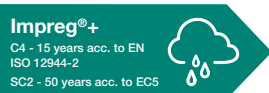
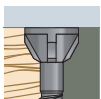

#### FBCB-E Impreg®+ Coating

References	Dimensions [mm]			Qty per Strip	Qty per Pack	Recommended RPM	QDPR051	QD76KE
	d <sub>h</sub>	d	l					
FBCB25E	6.8	3.9	25	30	2500	2500	✓	✓
FBCB35E	6.8	3.9	35	30	2500	2500	✓	✓

Each kit includes BIT2PE driver bit.

For additional technical data, such as load-bearing capacities, installation data and more, visit our website [www.strongtie.co.uk](http://www.strongtie.co.uk).



# Quik Drive® Collated Truck Bed/Standing-Seam Screws

## TBG TRUCK BED Screw, Outdoor

Suitable for fixing plywood or wood to steel or aluminium frames, the TBG is ideal use when fitting out truck beds.

- Wood to Steel (2.0 to 5.0 mm thickness) applications
- Ribbed Head
- Winged drill point to help clear hole and penetrate steel
- Bit (BIT3SUE) included

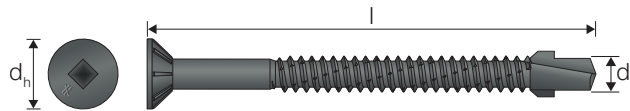

### TBG N2000 Mechanically Galvanised

References	Dimensions [mm]			Qty per Strip	Qty per Pack	Recommended RPM	QDHS60E / QDHS75E
	d <sub>h</sub>	d	l				
TBG645E	11.7	6.1	45	23	1000	1000-2500	✓
TBG660E	11.7	6.1	60	23	750	1000-2500	✓

### Quik Drive® Performance Data

#### Application to steel

Reference	Connection Detail	Performance Values				
		Pull out	Pull through		Shear	
		F <sub>k</sub> [kN]	F <sub>k</sub> [kN]	Min. Headside Material thickness	F <sub>k</sub> [kN]	Members
TBG645E	Wood to Steel	11.75	2.20	25	3.00	25 mm Wood to 4 mm Steel
TBG660E	Wood to Steel	11.75	2.20	40	3.25	40 mm Wood to 4 mm Steel

- 1) All Wood C24 grade
- 2) All steel in strength class S275

## PCULP STANDING SEAM ROOFING Screw

PCULP screw for installing standing-seam-roofing (or “snap and seam”) panels to wood.

- Ultra low profile pancake head
- Type 17 point
- Straight collation
- Yellow zinc dichromate
- Bit (BIT2SE) included

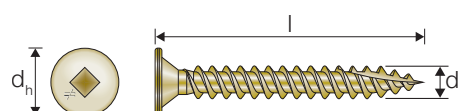

### PCULP - Yellow Zinc Plated

References	Dimensions [mm]			Qty per Strip	Qty per Pack	Recommended RPM	QDPROPP38
	d <sub>h</sub>	d	l				
PCULP40BE1012	10.3	5	40	30	1500	2500	✓

# Quik Drive® Collated Connector Screws

## Solid-Drive™ CSA CONNECTOR Screw



CSA is a self-drilling flat head screw with a type 17 point tip suitable for installing construction connectors such as angle brackets or joist hangers, to solid sawn and engineered wood joists. Available in electro galvanised carbon steel, Impreg+ coated carbon steel and A4 stainless steel.

- Use to install selected Simpson Strong-Tie connectors
- Pan head
- Type 17 point
- Bit (BITLTX20E) included
- Conical shape under the head for secure fit in connector holes

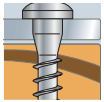

**Electro Galvanised**

C1 acc. to EN ISO 12944-2  
SC2 - 50 years acc. to EC5

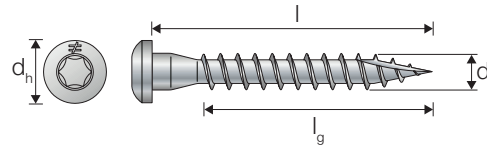

### CSA Electro Galvanised

References	Dimensions [mm]				Qty per Strip	Qty per Pack	Recommended RPM	QDBPC50E
	d <sub>h</sub>	d	l	l <sub>g</sub>				
CSA5.0X35T	8.3	5.0	35	29	25	1500	2500-4000	✓
CSA5.0X40T	8.3	5.0	40	34	25	1500	2500-4000	✓
CSA5.0X50T	8.3	5.0	50	34	25	1000	2500-4000	✓

### CSA Connector Screw

#### ETA-04/0013 | Characteristic Performance Values (C24 Graded Wood)

	References	Lateral F <sub>lat,K</sub> /Material Thickness [kN]			Axial F <sub>ax,K</sub> [kN]
		1.2 mm	1.5 to 2.0 mm	2.5 to 4.0 mm	
CSA	CSA5.0X35T	2.01	1.99	1.95	2.11
	CSA5.0X40T	2.27	2.25	2.21	2.47
	CSA5.0X50T	2.63	2.63	2.63	3.20

For additional technical data, such as load-bearing capacities, installation data and more, visit our website [www.strongtie.co.uk](http://www.strongtie.co.uk).

# Quik Drive® Collated Wood Flooring Screws

## Solid-Drive™ WSV SUBFLOOR Screw



Simpson Strong-Tie has re-engineered its popular subfloor screws to reduce driving force and increase installation speed. The WSV Subfloor screw has been developed for fastening subfloor sheathing to wood and I-joist framing using the Quik Drive® auto-feed screw driving system.

- Redesigned point and thread pattern provide easy starts and up to 25% less torque — which leads to faster driving
- Less installation torque also means less wear on tools
- Deep 6-lobe recess and ribbed underhead provide secure bit retention and clean countersinking
- The holding power of WSV screws reduces the gaps between the joist and subfloor that cause floor squeaks
- WSV screws can be easily backed out, allowing for future access to floor cavities
- CE-marked according to EN14592



**Yellow Zinc Plated**

C1 acc. to EN ISO 12944-2  
SC2 - 50 years acc. to EC5

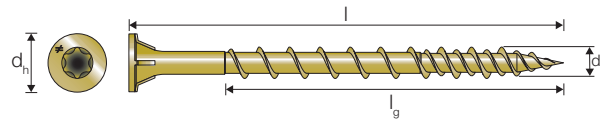

### WSV Yellow Zinc Plated

References	Dimensions [mm]				Qty per Strip	Qty per Pack	Recommended RPM	Bit	QDPR064E	QDPR076SKE
	d	l	d <sub>1</sub>	l <sub>g1</sub>						
WSV44E	4.6	44	8.46	31	30	2000	2500	T-25	✓	✓
WSV51E	4.6	51	8.46	37	30	2000	2500	T-25	✓	✓
WSV64E	4.6	64	8.46	50	30	1500	2500	T-25	✓	✓
WSV76E	4.6	76	8.46	55	30	1000	2500	T-25		✓

Each box includes BITTX25 driver bit.

For additional technical data, such as load-bearing capacities, installation data and more, visit our website [www.strongtie.co.uk](http://www.strongtie.co.uk).

# Quik Drive® Collated Wood Flooring Screws

## WSC WOOD FLOORING Screw, Coarse Thread



WSC is a screw with a sharp point and coarse thread, suitable for wood to wood applications such as flooring.

- Wood to wood applications
- Coarse thread
- WSC32E has Type 17 point and nibs under the head
- WSC38E has a sharp point without nibs under the head
- Bit (BIT2SE) included

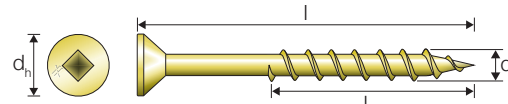
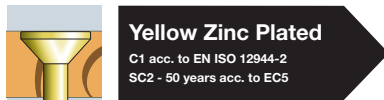

### WSC Yellow Zinc Plated

References	Dimensions [mm]			Qty per Strip	Qty per Pack	Recommended RPM	QDPRO51E	QD76KE
	d <sub>h</sub>	d	l					
WSC32E	8.4	4.2	32	30	2500	2500	✓	✓
WSC38E	8.4	4.2	38	30	2000	2500	✓	✓

### Quik Drive® Performance Data

#### Application to Wood

Reference	Connection Detail	Performance Values					
		Pull out		Pull through		Shear	
		F <sub>k</sub> [kN]	Min. Pointside Penetration	F <sub>k</sub> [kN]	Min. Headside Material thickness	F <sub>k</sub> [kN]	Members
WSC32E	Wood to Wood	1.15	22	0.70	25	0.35	16mm Wood to ≥ 16mm Wood
WSC38E		1.35	26	0.70	25	0.45	19 mm Wood to ≥ 19 mm Wood

- 1) All Wood C24 grade
- 2) All steel in strength class S275

### WSC Wood Flooring Screws

#### DoP-h10/0015 | Mechanical Properties (Wood Density ρ<sub>k</sub> = 350 kg/m<sup>3</sup>)

References	Yield Moment M <sub>yk</sub> [Nmm]	Withdrawal Parameter f <sub>ax,k</sub> [N/mm <sup>2</sup> ]	Head Pull-Through f <sub>head,k</sub> [N/mm <sup>2</sup> ]	Tensile Capacity f <sub>tens,k</sub> [kN]	Torsional Strength f <sub>tor,k</sub> [kN]	
WSC	All	3.67	11.50	8.10	7.00	5.10

For additional technical data, such as load-bearing capacities, installation data and more, visit our website [www.strongtie.co.uk](http://www.strongtie.co.uk).

# Quik Drive® Collated Wood Screws

## CHB WOOD FIBRE to Wood Screw



CHB is a wood fibre to wood screw, suitable for installing chipboard, plywood and OSB board to wood.

- Flat head with ribs
- Coarse thread
- Type 17 point
- Bit (BIT2SE) included

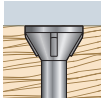

**Electro Galvanised**

C1 acc. to EN ISO 12944-2  
SC2 - 50 years acc. to EC5

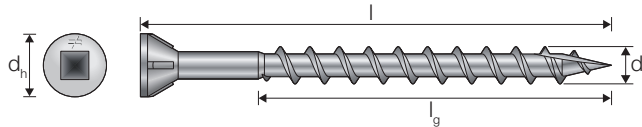

### CHB Electro Galvanised

References	Dimensions [mm]			Qty per Strip	Qty per Pack	Recommended RPM	QDPR051E	QDPR064E	QD76KE
	d <sub>h</sub>	d	l						
CHB51E	6.9	4.1	51	30	2000	2500	✓	✓	✓

For additional technical data, such as load-bearing capacities, installation data and more, visit our website [www.strongtie.co.uk](http://www.strongtie.co.uk).

# Quik Drive® Collated Cladding/Decking Screws

## CLSZN-E Wood FACADE Screw

Made for outdoor wood cladding. The flat head with fiber lock technology protects the wood from moisture, and the double thread ensures sufficient insertion, even in high density wood without the risk of spin-off.

- 6 lobe drive
- Flat head with fiber lock technology
- Double threaded
- Extreme ductility
- Wood facades to wood

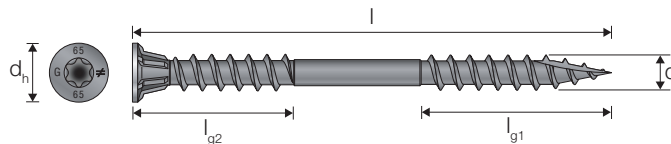
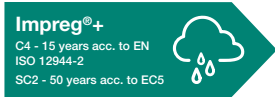

### CLSZN-E Impreg®+ Coating

References	Dimensions [mm]					Qty per Strip	Qty per Pack	Recommended RPM	QDPR076SKE
	d <sub>h</sub>	d	l	l <sub>g1</sub>	l <sub>g2</sub>				
CLSZN48E	8.0	4.8	48	26	18	30	1000	2500	✓
CLSZN65E	8.0	4.8	65	26	22	30	1000	2500	✓
CLSZN70E	8.0	4.8	70	26	30	30	1000	2500	✓

Each kit includes BITTX20 driver bit.

## Deck-Drive™ SSDTH WOOD CLADDING and DECKING Screw

SSDTH is a stainless steel screw with a trim head and sharp point tip suitable for wood cladding & decking installation.

- Wood cladding applications
- Wood decking applications
- Suitable for external use
- Sharp point
- Box thread
- 305 grade stainless steel
- Bit (BIT2SE) included

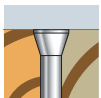

### SSDTH Stainless Steel A2

References	Dimensions [mm]			Qty per Strip	Qty per Pack	Recommended RPM	QD76KE	QDPR076SKE	QDPR076E
	d <sub>h</sub>	d	l						
SSDTH51E	6.3	4.2	51	30	1000	2500	✓	✓	✓
SSDTH64E	6.3	4.2	64	30	1000	2500	✓	✓	✓
SSDTH76E	6.3	4.2	76	30	1000	2500	✓	✓	

# Quik Drive® Collated Decking Screws

## Deck-Drive™ SS3DSC DECKING Screw

SS3DSC is a stainless steel screw designed for wood decking to wood.

- Wood decking applications
- Suitable for external use
- Sharp point
- Coarse thread
- Bit (BIT3SE) included

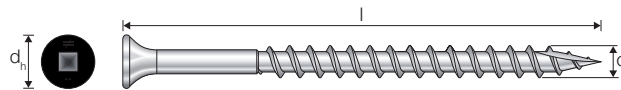
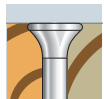

### SS3DSC Stainless Steel A2

References	Dimensions [mm]			Qty per Strip	Qty per Pack	Recommended RPM	QDPR076SKE	QDPR076FE
	d <sub>h</sub>	d	l					
SS3DSC64BE	8.5	4.9	64	30	1500	2500	✓	✓
SS3DSC76BE	8.5	4.9	76	30	1000	2500	✓	

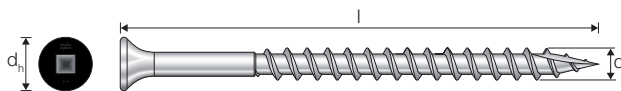
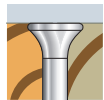

### SS3DSC Stainless Steel A4

References	Dimensions [mm]			Qty per Strip	Qty per Pack	Recommended RPM	QDPR076SKE	QDPR076FE
	d <sub>h</sub>	d	l					
SS3DSC64BE316	8.5	4.9	64	30	1500	2500	✓	✓
SS3DSC76BE316	8.5	4.9	76	30	1000	2500	✓	

## DTHQ Trim Head WOOD Screw

DTHQ is a ribbed head screw with a type 17 point and coarse thread, suitable for wood to wood applications.

- Wood to wood applications
- Ribbed head
- Type 17 point
- Coarse thread
- Bit (BIT2SUE) included

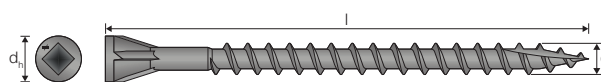
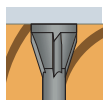

### DTHQ Quik Guard® Coating

References	Dimensions [mm]			Qty per Strip	Qty per Pack	Recommended RPM	QDPR064E	QD76KE	QDPR076SE
	d <sub>h</sub>	d	l						
DTHQ51E	6.2	4.2	51	30	2000	2500	✓	✓	✓
DTHQ64E	6.2	4.2	64	30	1500	2500	✓	✓	✓
DTHQ76E	6.2	4.5	76	30	1000	2500		✓	✓

# Quik Drive® Collated Decking Screws

## Deck-Drive™ SSDHPD HARDWOOD-DECKING Screw

SSDHPD is a stainless steel screw designed for hardwood decking to wood.

- Paddle point to penetrate the hardest wood products without pre-drilling
- Compact cap head ensures a low-profile installation and reduced visibility
- Wings on the shaft counter-bore hard material and allow the head to countersink for a clean look
- Bit (BIT2SE) included

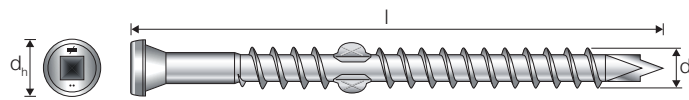

### SSDHPD Stainless Steel A2

Reference	Dimensions [mm]			Qty per Strip	Qty per Pack	Recommended RPM	QDPR076SKE	QDPR0RFE
	d <sub>h</sub>	d	l					
SSDHPD64E	6.9	5.0	64	30	1000	2500	✓	✓

## Deck-Drive™ SSBFHSD Bi-Metal WOOD to METAL Screw

The SSBFHSD bi-metal screw is designed for timber to steel joist (1.2–2.4 mm steel thickness) applications. The winged design cuts a clearance hole. The bi-metal design consists of 316 stainless steel and a carbon steel tip which is perfect for steel joist applications without compromising on corrosion resistance.

Pre-drilling and countersink may be necessary at ends, butt joints, and on applications where denser material is used. Follow board manufacturers recommendations where applicable.

- Drives easily through 1.2–2.4 mm steel without pre-drilling
- A4 Stainless steel for severe corrosion resistance
- Winged design avoids sheet ride
- Zinc coating to avoid dissimilar metal corrosion
- Timber-to-steel decking
- Maximum recommended board thickness 28 mm
- Recommended steel thickness 1.2–2.4 mm

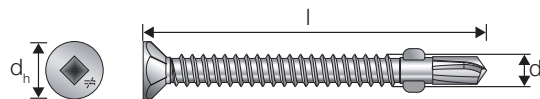

### SSBFHSD Stainless Steel A4 with carbon steel tip

References	Dimensions [mm]			Qty per Strip	Qty per Pack	Recommended RPM	QDPR0LDHG2
	d	l	d <sub>h</sub>				
SSBFHSD2SE	4.9	50	8.5	25	1000	2500	✓

Each kit includes BIT2SE driver bit.



# Quik Drive® Collated Roofing Screws

## SSWSCB TILE ROOFING Screw, Coarse Thread



SSWSCB is a stainless steel screw with a bugle head, coarse thread and a type 17 point. It is ideally suited to fastening roof tiles to wood.

- Tile roofing to wood applications
- Suitable for external use
- Type 17 point
- Coarse thread
- Bit (BIT2SE) included

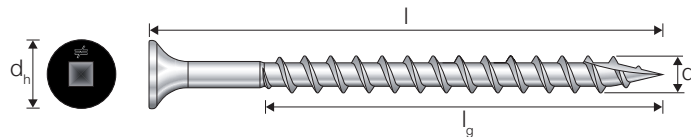
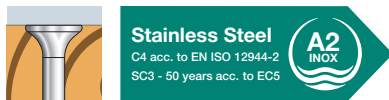

### SSWSCB Stainless Steel A2

References	Dimensions [mm]			Qty per Strip	Qty per Pack	Recommended RPM	QD76KE	QDPRO76SKE	QDPRO9FE
	d <sub>h</sub>	d	l						
SSWSCB32E	8.4	4.6	32	30	2500	2500	✓	✓	✓
SSWSCB51E	8.4	4.6	51	30	2000	2500	✓	✓	✓

### Quik Drive® Performance Data

#### Application to Wood

Reference	Connection Detail	Performance Values					
		Pull out		Pull through		Shear	
		F <sub>k</sub> [kN]	Min. Pointside Penetration	F <sub>k</sub> [kN]	Min. Headside Material thickness	F <sub>k</sub> [kN]	Members
SSWSB51E	Softwood Decking to Wood	2.35	35	2.15	30	1.35	21 mm Softwood decking to ≥ 32 mm Wood
SSWSCB64E		3.60	50	2.15	30	1.55	32 mm Softwood decking to ≥ 32mm Wood

- 1) All wood C24 grade
- 2) All steel in strength class S275

### SSWSCB Tile Roofing Screws

#### DoP-h13/0006 | Mechanical Properties (Wood Density ρ<sub>k</sub> = 350 kg/m<sup>3</sup>)

	Reference	Yield Moment M <sub>y,k</sub> [Nmm]	Withdrawal Parameter f <sub>ax,k</sub> [N/mm <sup>2</sup> ]	Head Pull-Through f <sub>head,k</sub> [N/mm <sup>2</sup> ]	Tensile Capacity f <sub>tens,k</sub> [kN]	Torsional Strength f <sub>tor,k</sub> [kN]
SSWSCB	All	2.60	14.00	16.00	4.70	4.20

For additional technical data, such as load-bearing capacities, installation data and more, visit our website [www.strongtie.co.uk](http://www.strongtie.co.uk).

# Quik Drive® Collated Metal Screws

## PHSD STEEL FRAMING Screw, Pan Head

PHSD is a self-drilling pan head screw with a drill point tip suitable for light gauge steel frame assembly.

- Light gauge steel framing (0.9 to 2.5mm thickness) applications
- Pan head
- #2 Drill point with fine thread
- Free bit (BIT2SE) included

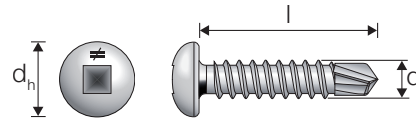

### PHSD Electro Galvanised

References	Dimensions [mm]			Steel thickness (mm)	Qty per Strip	Qty per Pack	Recommended RPM	QDPROPHG2
	d <sub>h</sub>	d	l					
PHSD34S0818	8	4.1	19	0.9-2.5	23	2500	2500	✓

## FPHSD STEEL FRAMING Screw, Flat Head

FPHSD is a self-drilling flat pan head screw with a drill point tip suitable for light gauge steel frame assembly.

- Light gauge steel framing (2.8 to 5.3 mm thickness) applications
- Flat pan head
- Drill point with fine thread
- Bit (BIT3SE) included

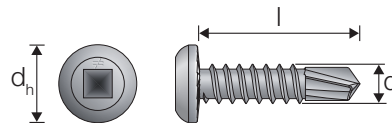

### FPHSD Electro Galvanised

References	Dimensions [mm]			Steel thickness (mm)	Qty per Strip	Qty per Pack	Recommended RPM	QDPROPHG2
	d <sub>h</sub>	d	l					
FPHSD34S1016	9	4.8	19	2.8-4.4	23	2500	2500	✓
FPHSD34S1214	9	5.5	19	2.8-5.3	23	2500	2500	✓

## X SELF-DRILLING METAL Screw

Self drilling screw for steel decking to structural steel, steel stitching ("side-lap" stitching) and cold-formed steel framing applications.

- 8 mm hex head
- #3 drill point
- Hex washer head
- Straight collation

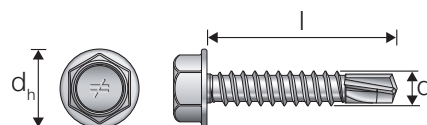
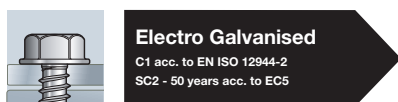

### X Electro Galvanised

References	Dimensions [mm]			Qty per Strip	Qty per Pack	Recommended RPM	QDPROHX516G2	QDPROPP38KE
	d <sub>h</sub>	d	l					
X25E1016	8	4.7	25	22	1500	2500	✓	✓
X1S1214	8	5.5	25	22	1500	2500	✓	✓

# Solid Wood Fastener Dimensioning Software



## Calculating wood fastening connections has never been easier

In just four simple steps, Solid Wood helps you calculate and select fastening solutions suitable for the specific wood structure at hand, according to Eurocode 5 and our ETA.

- **Time saving** - Quicker and easier than doing manual calculations
- **Safety** - Removes any doubt in the precision of your manual calculations
- **Product guide** - Helps you find the correct product for your application

The software generates a PDF-report that can be used as documentation for the project.

[solidwood.strongtie.eu](http://solidwood.strongtie.eu)

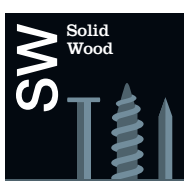

Calculation in four simple steps.

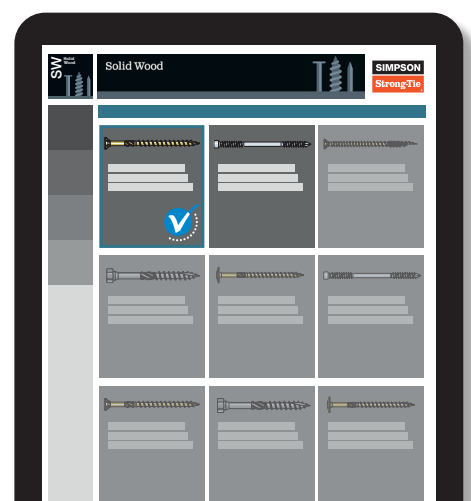
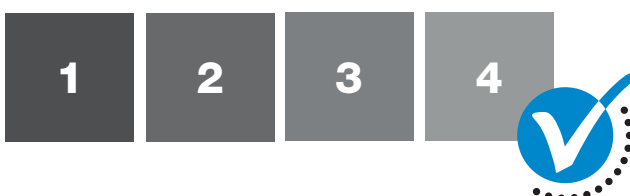



# Alphabetical Index





# Alphabetical Index

ESCRFTC12.0X400 .....	46
ESCRFTC12.0X450 .....	46
ESCRFTC12.0X500 .....	46
ESCRFTC12.0X600 .....	46
ESCRFTC8.0X120 .....	46
ESCRFTC8.0X140 .....	46
ESCRFTC8.0X160 .....	46
ESCRFTC8.0X180 .....	46
ESCRFTC8.0X200 .....	46
ESCRFTC8.0X220 .....	46
ESCRFTC8.0X240 .....	46
ESCRFTC8.0X260 .....	46
ESCRFTC8.0X280 .....	46
ESCRFTC8.0X300 .....	46
ESCRFTC8.0X350 .....	46
ESCRFTC8.0X400 .....	46
ESCRFTC8.0X450 .....	46
ESCRFTZ8.0X120 .....	47
ESCRFTZ8.0X140 .....	47
ESCRFTZ8.0X160 .....	47
ESCRFTZ8.0X180 .....	47
ESCRFTZ8.0X200 .....	47
ESCRFTZ8.0X220 .....	47
ESCRFTZ8.0X240 .....	47
ESCRFTZ8.0X260 .....	47
ESCRFTZ8.0X280 .....	47
ESCRFTZ8.0X300 .....	47
ESCRFTZ8.0X350 .....	47
ESCRFTZ8.0X400 .....	47

## F

FBCB25E.....	104
FBCB3.9X25.....	58
FBCB3.9X25.....	58
FBCB3.9X35.....	58
FBCB35E.....	104
FBCS25E.....	104
FBCS3.9X25.....	57
FBCS3.9X25.....	57
FBCS3.9X35.....	57
FBCS3.9X35.....	57
FBCS35E.....	104
FBCS45E.....	104
FHSD32E0818.....	102
FHSD45E.....	102
FHSD64E.....	102
FPHSD34S1016.....	114
FPHSD34S1214.....	114
FSM4.2X14.....	55
FSM4.8X16.....	55

## G

GSCREW.....	59
-------------	----

## H

HS4.2X13.....	56
HS4.2X19.....	56
HSB4.2X13.....	56
HSB4.2X19.....	56

HSB4.2X25.....	56
----------------	----

## M

MANDREL128E.....	91
MANDREL128E-RC.....	91
MANDREL131E-RC.....	91
MANDREL165E-RC.....	91
MANDREL191E-RC.....	91
MANDREL254E.....	91
MTH25E.....	100
MTH32E.....	100
MTH32SE.....	100
MTHZ19E.....	100
MTHZ25E.....	100

## N

N3.75X30SH/1KG.....	63
N3.75X30SH/2.5KG.....	63
N3.75X30SH/25KG.....	63
N3.75X30SH/5KG.....	63
NPA25G2.....	91
NPA2G2.....	91
NPA3G2.....	91
NPABPC50E.....	91
NPADECKAE-RC.....	91

## P

PCULP40BE1012.....	105
PFEEDPAWL2E.....	91
PFEEDPAWL3E.....	91
PFEEDPAWLE.....	91
PFEEDPAWLTLE.....	91
PHSD34S0818.....	114
PNOSECLIP.....	91

## Q

QD76KE.....	82
QDBPC19EF.....	76
QDBPC19EFKEGFS23.....	76
QDBPC50E.....	75
QDDECKCLIP-RC.....	91
QDEXTE.....	91
QDEXTG2-T2.....	91
QDEXTG2-T3.....	91
QDEXTG3-22.....	91
QDHSD60E.....	78
QDHSD60KE.....	78
QDHSD75E.....	78
QDLEAFSPRING.....	91
QDLEAFSPRING2.....	91
QDPRO51E.....	80
QDPRO51KE.....	80
QDPRO64E.....	81
QDPRO64KE.....	81
QDPRO76SKE.....	77
QDPROHX516G2.....	86
QDPROLDHG2.....	84

QDPROPHG2.....	85
QDPROPP38KE.....	87
QDPRORFE.....	83
QDSPRING1E.....	91
QDSPRING2E.....	91
QDSPRING3E.....	91
QDSPRING4E.....	91
QRP2E-50.....	88
QRS2E-50.....	88
QRS3E-50.....	88
QRSU2E-50.....	88
QRSU3-50.....	88
QUIVER.....	91

## R

RDPF40PE.....	99
RDWF30BE.....	99
RDWF40BE.....	99
RSN34G2.8X65.....	69
RSN34G2.8X75.....	69
RSN34G3.1X90.....	69
RSN34G3.1X98.....	69
RSND34G2.8X65.....	69
RSND34G2.8X75.....	69
RSND34G3.1X90.....	69
RSND34G3.1X98.....	69
RTFSD25E.....	99
RTFSD35E.....	99

## S

SDW22258-R50E.....	48
SDW22300-R50E.....	48
SDW22338-R50E.....	48
SDW22438-R50E.....	48
SDW22458-R50E.....	48
SDW22500-R50E.....	48
SDW22600-R50E.....	48
SDW22634-R50E.....	48
SDW22638-R50E.....	48
SPA51E.....	91
SPA76E.....	91
SS3DSC64BE.....	111
SS3DSC64BE316.....	111
SS3DSC76BE.....	111
SS3DSC76BE316.....	111
SSBFHSD2SE.....	112
SSDHPD64E.....	112
SSDTH51E.....	110
SSDTH64E.....	110
SSDTH76E.....	110
SSH10.0X100.....	39
SSH10.0X100.....	39
SSH10.0X120.....	39
SSH10.0X120.....	39
SSH10.0X140.....	39
SSH10.0X160.....	39
SSH10.0X180.....	39
SSH10.0X200.....	39
SSH10.0X240.....	39
SSH10.0X280.....	39
SSH10.0X40.....	39

## Alphabetical Index

SSH10.0X40 .....	39	SWC10.0X340 .....	44	SWWW6.0X240 .....	41
SSH10.0X40A4 .....	40	SWC10.0X360 .....	44	SWWW6.0X260 .....	41
SSH10.0X50 .....	39	SWC10.0X380 .....	44	SWWW6.0X280 .....	41
SSH10.0X50 .....	39	SWC10.0X400 .....	44	SWWW6.0X300 .....	41
SSH10.0X60 .....	39	SWC6.0X200 .....	43	SWWW6.0X60 .....	41
SSH10.0X60 .....	39	SWC6.0X220 .....	43	SWWW6.0X80 .....	41
SSH10.0X80 .....	39	SWC6.0X240 .....	43	SWWW8.0X100 .....	41
SSH10.0X80 .....	39	SWC6.0X260 .....	43	SWWW8.0X120 .....	41
SSH10.0X90 .....	39	SWC6.0X280 .....	43	SWWW8.0X140 .....	41
SSH10.0X90 .....	39	SWC6.0X300 .....	43	SWWW8.0X160 .....	41
SSH12.0X100 .....	39	SWC8.0X100 .....	43	SWWW8.0X180 .....	41
SSH12.0X120 .....	39	SWC8.0X120 .....	43	SWWW8.0X200 .....	41
SSH12.0X140 .....	39	SWC8.0X140 .....	43	SWWW8.0X220 .....	41
SSH12.0X160 .....	39	SWC8.0X160 .....	43	SWWW8.0X240 .....	41
SSH12.0X180 .....	39	SWC8.0X180 .....	43	SWWW8.0X260 .....	41
SSH12.0X200 .....	39	SWC8.0X200 .....	43	SWWW8.0X280 .....	41
SSH12.0X60 .....	39	SWC8.0X220 .....	43	SWWW8.0X300 .....	41
SSH12.0X80 .....	39	SWC8.0X240 .....	43	SWWW8.0X320 .....	41
SSH12.0X90 .....	39	SWC8.0X260 .....	43	SWWW8.0X340 .....	42
SSH6.0X120 .....	38	SWC8.0X280 .....	43	SWWW8.0X360 .....	42
SSH6.0X40 .....	38	SWC8.0X300 .....	43	SWWW8.0X380 .....	42
SSH6.0X40 .....	38	SWC8.0X320 .....	43	SWWW8.0X400 .....	42
SSH6.0X50 .....	38	SWC8.0X340 .....	43	SWWW8.0X80 .....	41
SSH6.0X50 .....	38	SWC8.0X360 .....	43		
SSH6.0X60 .....	38	SWC8.0X380 .....	43		
SSH6.0X75 .....	38	SWC8.0X400 .....	43		
SSH6.0X90 .....	38	SWC8.0X80 .....	43		
SSH8.0X100 .....	39	SWD6.5X130 .....	45	<b>T</b>	
SSH8.0X100 .....	39	SWD6.5X160 .....	45	TBG645E .....	105
SSH8.0X120 .....	39	SWD6.5X190 .....	45	TBG660E .....	105
SSH8.0X140 .....	39	SWD6.5X220 .....	45	TOOLCASE-LG .....	91
SSH8.0X160 .....	39	SWD6.5X65 .....	45	TTFA44.2X35 .....	52
SSH8.0X180 .....	39	SWD6.5X90 .....	45	TTFA44.2X45 .....	52
SSH8.0X200 .....	39	SWD8.0X130 .....	45	TTFA44.2X45 .....	52
SSH8.0X240 .....	39	SWD8.0X160 .....	45	TTFA44.2X55 .....	52
SSH8.0X260 .....	39	SWD8.0X190 .....	45	TTFA44.2X55 .....	52
SSH8.0X280 .....	39	SWD8.0X220 .....	45	TTFA44.8X75 .....	52
SSH8.0X300 .....	39	SWD8.0X245 .....	45	TTFA44.8X75 .....	52
SSH8.0X40 .....	39	SWD8.0X275 .....	45	TTSFS5.0X100 .....	51
SSH8.0X40 .....	39	SWD8.0X300 .....	45	TTSFS5.0X120 .....	51
SSH8.0X50 .....	39	SWD8.0X330 .....	45	TTSFS5.0X60 .....	51
SSH8.0X50 .....	39	SWD8.0X90 .....	45	TTSFS5.0X70 .....	51
SSH8.0X60 .....	39	SWWW10.0X100 .....	42	TTSFS5.0X80 .....	51
SSH8.0X60 .....	39	SWWW10.0X120 .....	42	TTSFS5.0X90 .....	51
SSH8.0X80 .....	39	SWWW10.0X140 .....	42	TTSFS6.0X100 .....	51
SSH8.0X80 .....	39	SWWW10.0X160 .....	42	TTSFS6.0X120 .....	51
SSH8.0X80 .....	39	SWWW10.0X180 .....	42	TTSFS6.0X140 .....	51
SSH8.0X90 .....	39	SWWW10.0X200 .....	42	TTSFS6.0X70 .....	51
SSH8.0X90 .....	39	SWWW10.0X220 .....	42	TTSFS6.0X80 .....	51
SSP3.9X14 .....	55	SWWW10.0X240 .....	42	TTSFS6.0X90 .....	51
SSWSB51E .....	113	SWWW10.0X260 .....	42	TTUFS3.0X16 .....	49
SSWSCB32E .....	113	SWWW10.0X280 .....	42	TTUFS3.0X20 .....	49
SSWSCB51E .....	113	SWWW10.0X300 .....	42	TTUFS3.0X25 .....	49
SSWSCB64E .....	113	SWWW10.0X320 .....	42	TTUFS3.0X30 .....	49
SWC10.0X100 .....	44	SWWW10.0X340 .....	42	TTUFS3.0X40 .....	49
SWC10.0X120 .....	44	SWWW10.0X360 .....	42	TTUFS3.5X16 .....	49
SWC10.0X140 .....	44	SWWW10.0X380 .....	42	TTUFS3.5X20 .....	49
SWC10.0X160 .....	44	SWWW10.0X400 .....	42	TTUFS3.5X25 .....	49
SWC10.0X180 .....	44	SWWW6.0X100 .....	41	TTUFS3.5X30 .....	49
SWC10.0X200 .....	44	SWWW6.0X120 .....	41	TTUFS3.5X35 .....	49
SWC10.0X220 .....	44	SWWW6.0X140 .....	41	TTUFS3.5X40 .....	49
SWC10.0X240 .....	44	SWWW6.0X160 .....	41	TTUFS3.5X50 .....	49
SWC10.0X260 .....	44	SWWW6.0X180 .....	41	TTUFS3.5X50 .....	49
SWC10.0X280 .....	44	SWWW6.0X200 .....	41	TTUFS4.0X20 .....	49
SWC10.0X300 .....	44	SWWW6.0X220 .....	41	TTUFS4.0X25 .....	49
SWC10.0X320 .....	44				



# Alphabetical Index

TTUFS4.0X30 .....49  
 TTUFS4.0X30 .....49  
 TTUFS4.0X35 .....49  
 TTUFS4.0X40 .....49  
 TTUFS4.0X40 .....49  
 TTUFS4.0X45 .....49  
 TTUFS4.0X45 .....49  
 TTUFS4.0X50 .....49  
 TTUFS4.0X50 .....49  
 TTUFS4.0X60 .....49  
 TTUFS4.0X60 .....49  
 TTUFS4.0X70 .....49  
 TTUFS4.5X25 .....50  
 TTUFS4.5X30 .....50  
 TTUFS4.5X35 .....50  
 TTUFS4.5X35 .....50  
 TTUFS4.5X40 .....50  
 TTUFS4.5X40 .....50  
 TTUFS4.5X45 .....50  
 TTUFS4.5X45 .....50  
 TTUFS4.5X50 .....50  
 TTUFS4.5X50 .....50  
 TTUFS4.5X60 .....50  
 TTUFS4.5X60 .....50  
 TTUFS4.5X70 .....50  
 TTUFS4.5X80 .....50  
 TTUFS5.0X100 .....50  
 TTUFS5.0X120 .....50  
 TTUFS5.0X30 .....50  
 TTUFS5.0X35 .....50  
 TTUFS5.0X40 .....50  
 TTUFS5.0X40 .....50  
 TTUFS5.0X45 .....50  
 TTUFS5.0X50 .....50  
 TTUFS5.0X50 .....50  
 TTUFS5.0X60 .....50  
 TTUFS5.0X60 .....50  
 TTUFS5.0X70 .....50  
 TTUFS5.0X80 .....50  
 TTUFS5.0X90 .....50  
 TTUFS6.0X100 .....50  
 TTUFS6.0X120 .....50  
 TTUFS6.0X140 .....50  
 TTUFS6.0X160 .....50  
 TTUFS6.0X180 .....50  
 TTUFS6.0X30 .....50  
 TTUFS6.0X40 .....50  
 TTUFS6.0X50 .....50  
 TTUFS6.0X50 .....50  
 TTUFS6.0X60 .....50  
 TTUFS6.0X60 .....50  
 TTUFS6.0X70 .....50  
 TTUFS6.0X80 .....50  
 TTUFS6.0X90 .....50

## X

X1S1214 ..... 114  
 X25E1016 ..... 114

## W

WSC32E .....108  
 WSC38E .....108  
 WSHL45E .....101  
 WSV44E .....107  
 WSV51E .....107  
 WSV64E .....107  
 WSV76E .....107

# Notes

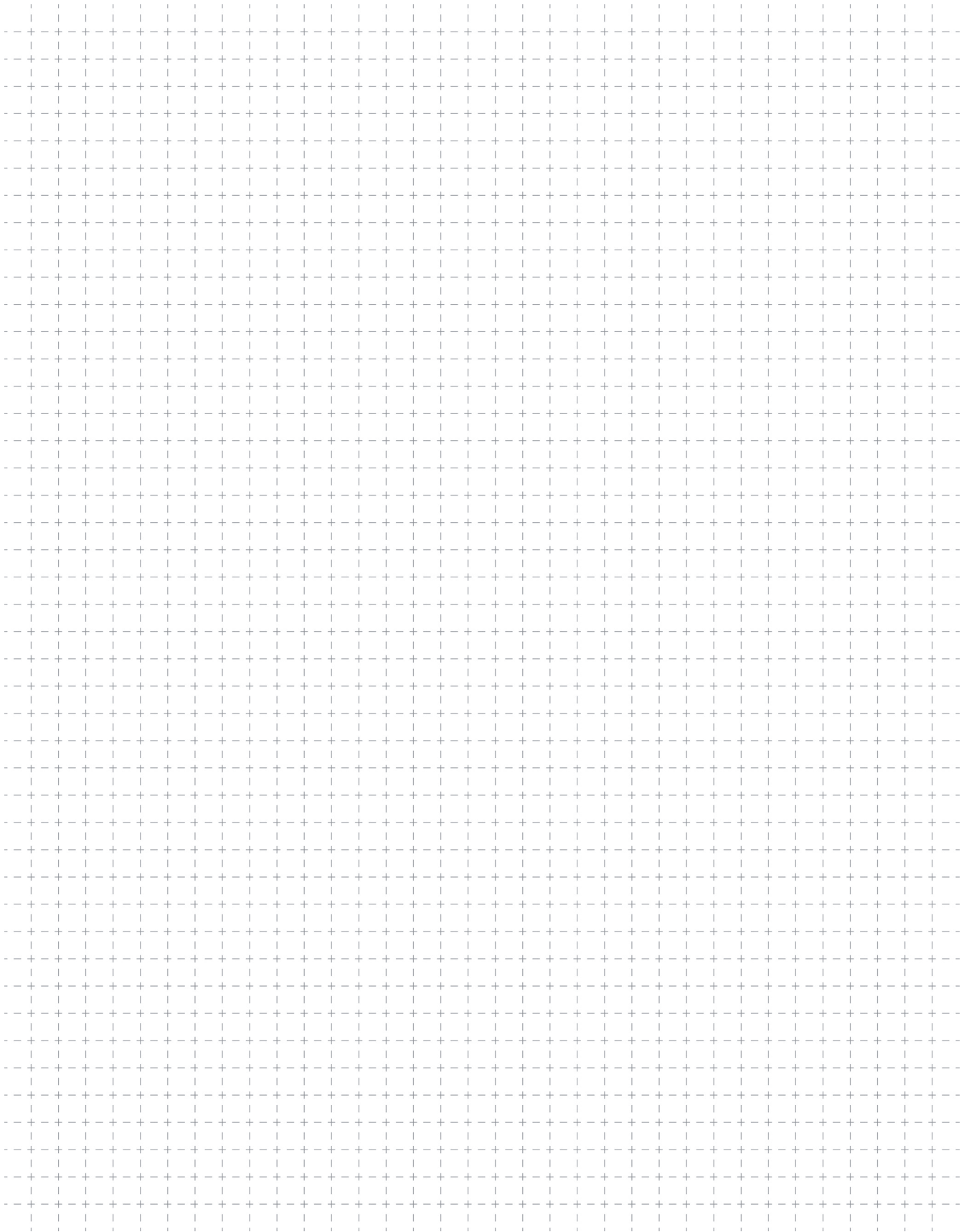

### Solid Wood Fastener Dimensioning Software

In just four simple steps, Solid Wood guides you through the calculation and selection of fastening solutions suitable for the specific wood structure at hand, all according to Eurocode 5 and our ETA.

Try Solid Wood today. Go to [solidwood.strongtie.eu](https://solidwood.strongtie.eu)

# Solid-Drive™

## High-Performance Structural Wood Fasteners.



### Solid Wood Fastener Dimensioning Software

In just four simple steps, Solid Wood guides you through the calculation and selection of fastening solutions suitable for the specific wood structure at hand, all according to Eurocode 5 and our ETA.

Try Solid Wood today. Go to [solidwood.strongtie.eu](http://solidwood.strongtie.eu)

### Fasteners engineered with engineers in mind.

Solid-Drive fasteners make the jobs of engineers and builders easier. Their high-performance design increases your allowable loads while speeding installation — lowering labour and materials costs.

Our ETA documentation gives engineers higher safety and flexibility in their specification of wood structures and includes thorough documentation of CLT, LVL and rafter insulation fastening.

Quality. Speed. Strength. Availability. Work smarter with Simpson Strong-Tie® fasteners.

To learn more, go to [strongtie.co.uk](http://strongtie.co.uk)

**SIMPSON**

**Strong-Tie®**

At Simpson Strong-Tie®, we do innovation a little differently. It's part of our legacy, part of our mission, and part of our future. Through precision engineering and rigorous testing, we're pushing the boundaries of product design to meet ever-greater challenges of the industry. It's our job to meet your most demanding applications with the fastest, easiest and strongest solutions, and it's our promise to deliver the expert knowledge and support you need to build safer and smarter.



# Fastening Reimagined.